

# Training Workshop for Infiltration/Inflow Control Program

Presented by:

Justine Skawski - MWRD

Adam Witek - MWRD

Alan Hollenbeck - RJN Group, Inc.



# TRAINING OUTLINE

- **Historical Perspective**
- WMO Article 8
- Infiltration/Inflow Basics
- Technical Guidance Manual
  - Definitions
  - Short-Term Requirements
  - Private Sector Program
  - Long-Term Program



# MWRD SEPARATE SEWER AND COMBINED SEWER AREAS

## LEGEND:

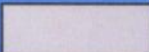
-  Separate/Unsewered area, 508.5 sq. mi.
-  Combined Sewer area, 375 sq. mi.

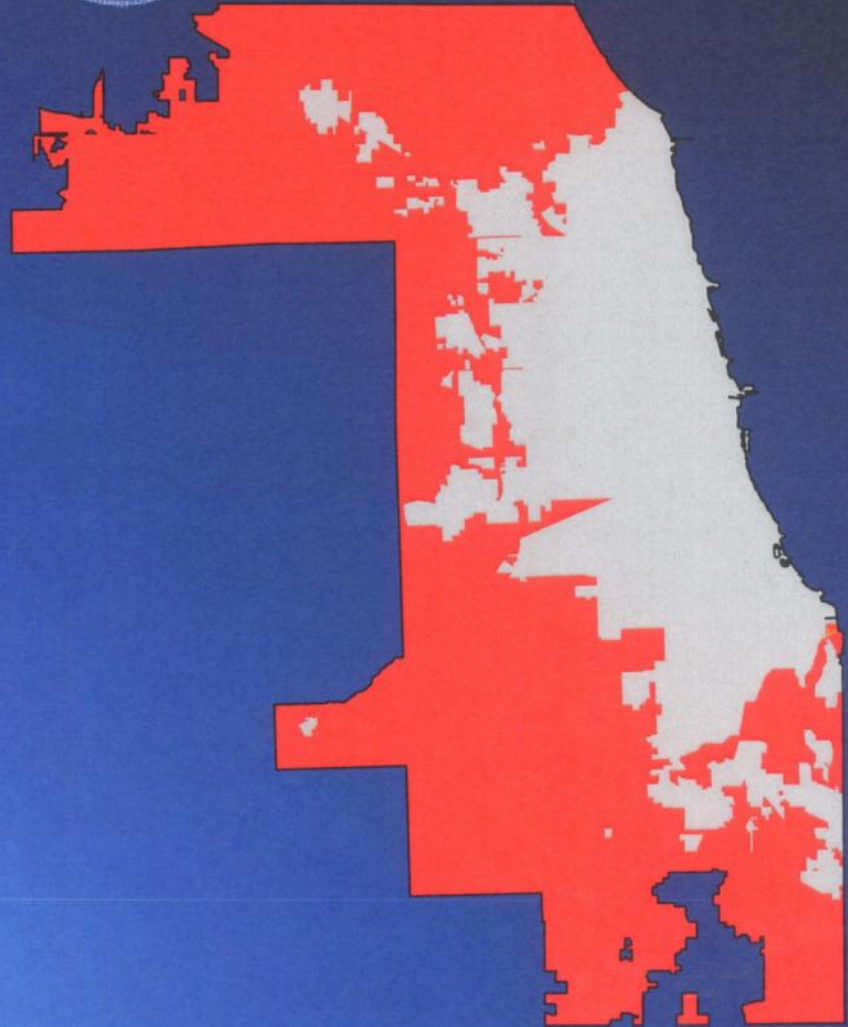

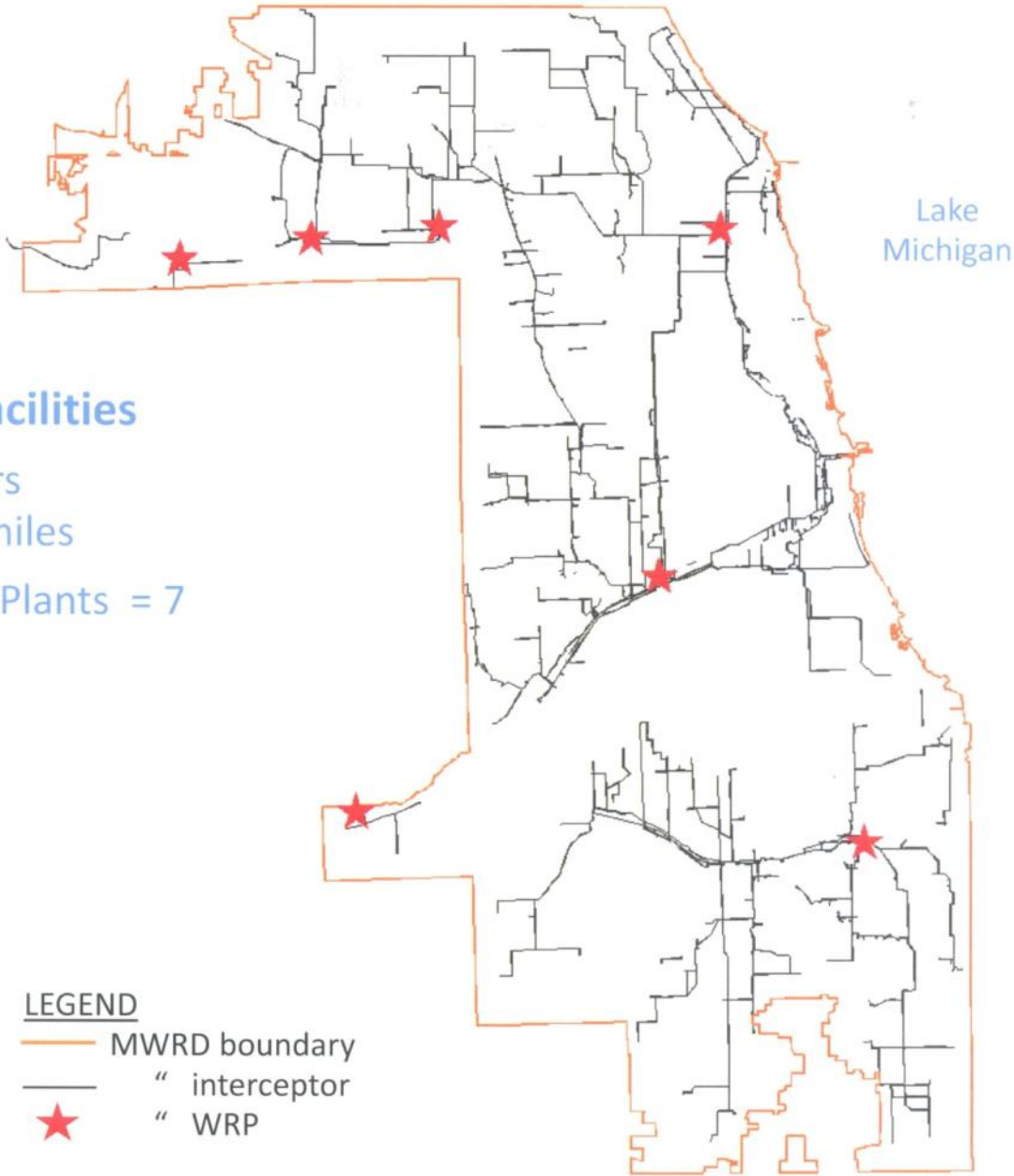

### MWRD Facilities

Interceptors  
= 554 miles

Treatment Plants = 7

- LEGEND**
- MWRD boundary
  - " interceptor
  - ★ " WRP

# Historical Perspective

- Sewer Summit Agreement 1985
- MWRD NPDES Permit Renewals
- ATP Committee
- Public Meetings

# Sewer Summit Agreement 1985

- Negotiations with the Tributary Agencies and COGs Resulting in Enactment of Sewer Summit Agreement in 1985 with Endorsement from the USEPA and IEPA
- Two Compliance Options
  - 150 gpcpd daily average wet-weather flow
  - Cost-effectiveness based ICAP

# MWRD NPDES Permit Renewals

- NPDES Permits Effective January 1, 2014
- IEPA Has Imposed a Special Condition in the NPDES Permits that Requires the System Owners to Implement Measures in Addition to the Sewer Summit Agreement if Excessive Wet-Weather Flow Causes or Contributes to Basement Backup or SSOs

# ATP Committee

- ATP Members: USEPA, IEPA, COGs-sponsored Representatives from Member Municipalities, Local Sanitary Districts, Utility Companies, Consulting Engineers and MWRD Staff
- ATP Formed in 2011 to Collaboratively Develop an I/I Program to Comply with the NPDES Special Conditions
- ATP Held Meetings and Has Developed an I/I Control Program to Address the Regulatory Requirements



# Public Meetings - 2014

- Reviewed Requirements of the New Infiltration/Inflow Reduction Program
- West Central Municipal Conference - Northlake – February 6, 2014
- Southwest Conference of Mayors - Chicago Ridge – February 19, 2014
- Northwest Municipal Conference - Mount Prospect – February 24, 2014
- South Suburban Mayors and Manager Association - East Hazel Crest – March 13, 2014

# TRAINING OUTLINE

- Historical Perspective
- **WMO Article 8**
- Infiltration/Inflow Basics
- Technical Guidance Manual
  - Definitions
  - Short-Term Requirements
  - Private Sector Program
  - Long-Term Program

# WMO Ordinance Article 8

- Adopted July 10, 2014
- Scope and Goals
  - Prevent SSO's and basement backups
  - Comply with NPDES Permit conditions
  - Reduce wet-weather flows to MWRD WWTP's
- Applicability
  - All satellite agencies that own and/or operate separate sanitary sewer systems tributary to MWRD

# WMO Ordinance Article 8 (Cont.)

- Short Term Requirements
- Private Sector Program
- Long Term O & M Program
- Annual Reporting
- Non-Compliance

# TRAINING OUTLINE

- Historical Perspective
- WMO Article 8
- **Infiltration/Inflow Basics**
- Technical Guidance Manual
  - Definitions
  - Short-Term Requirements
  - Private Sector Program
  - Long-Term Program



# Consequences of Ineffective I/I Control

**NPDES  
Permit  
Violations**

**Consent  
Decrees**

**Regulatory  
Fines**

**Higher  
Conveyance  
&  
Treatment  
Costs**

# Consequences of Ineffective I/I Control



# Infiltration/Inflow Basics

- Extraneous Flow that Enters from Two Different Sources
- **Inflow** Is Rain or Surface Water that Finds Direct Entrance by Way of Downspouts, Sump Pumps, Manholes, and Catch Basins
- **Infiltration** Is Groundwater that Enters through Defective Pipes, Manholes, or Building Connections



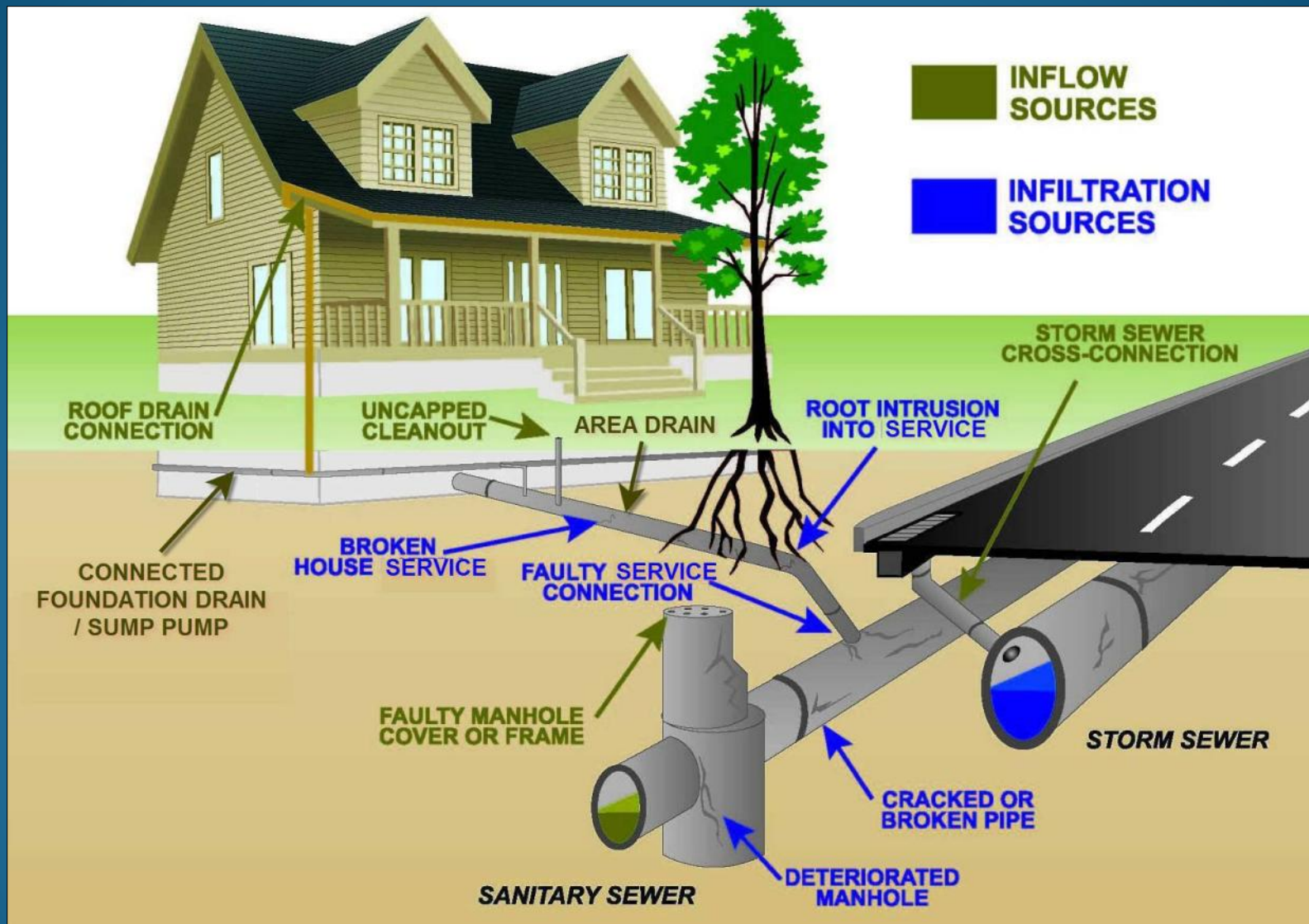

# Wastewater Collection-Textbook

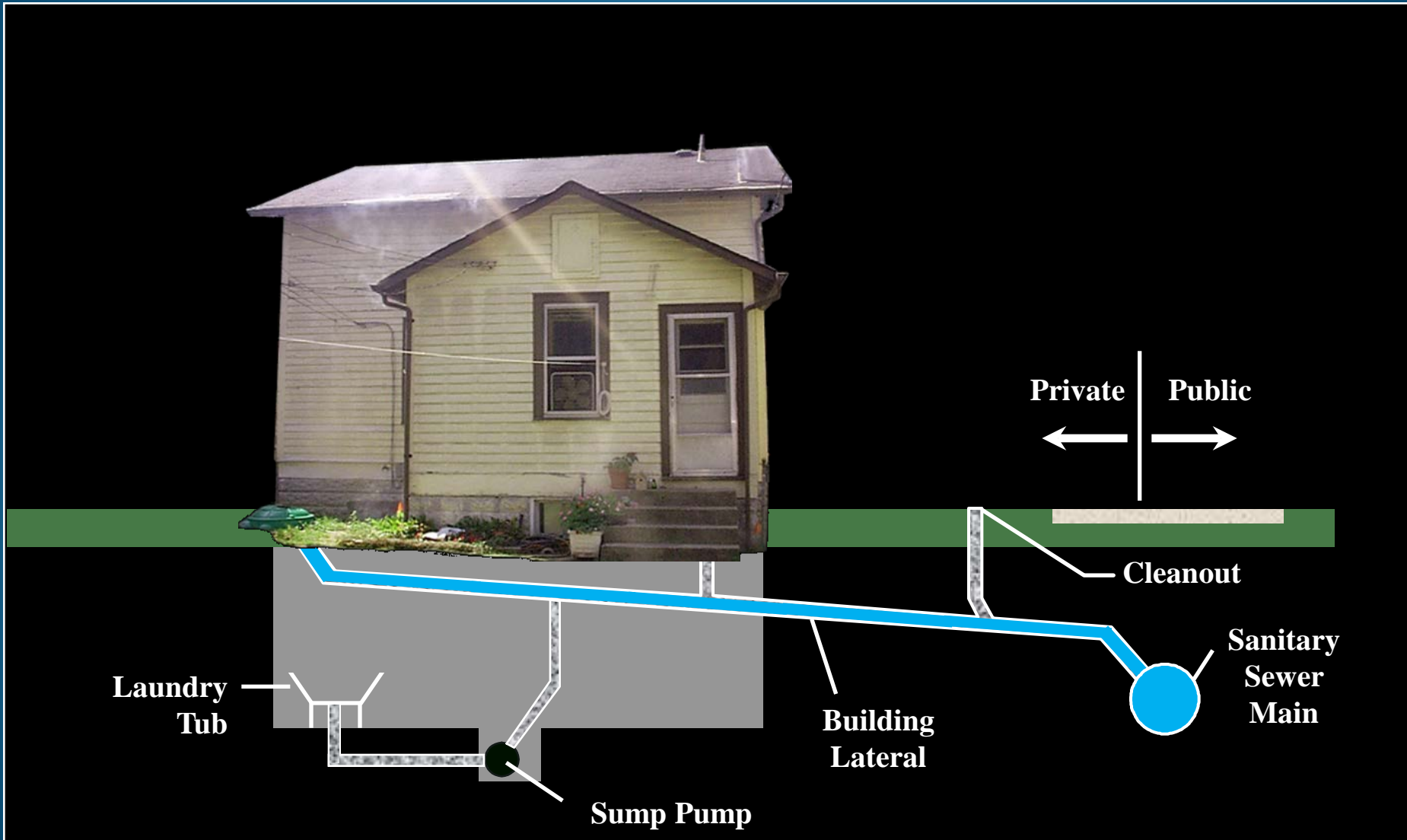

# Wastewater Collection-Textbook

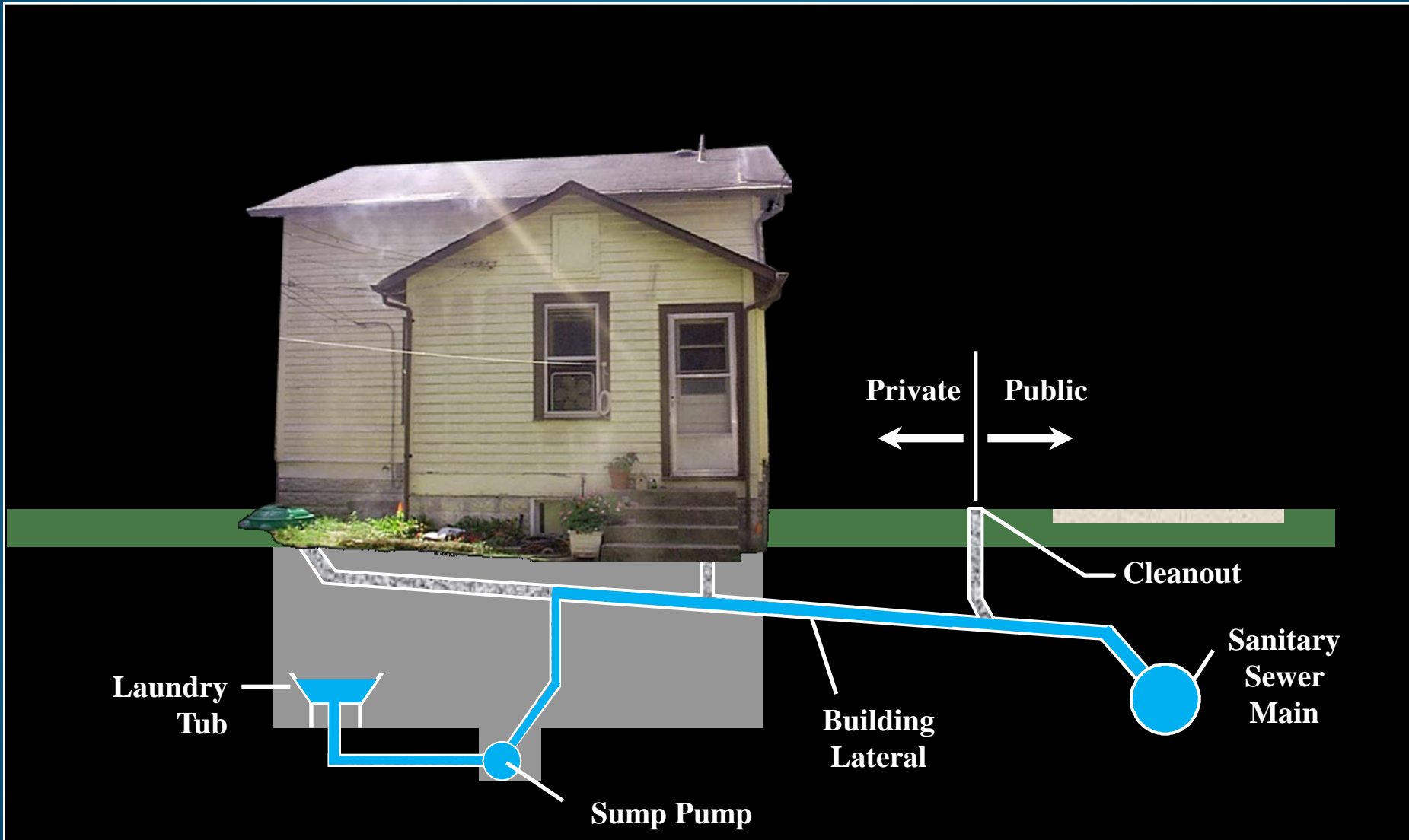

# Wastewater Collection-Textbook

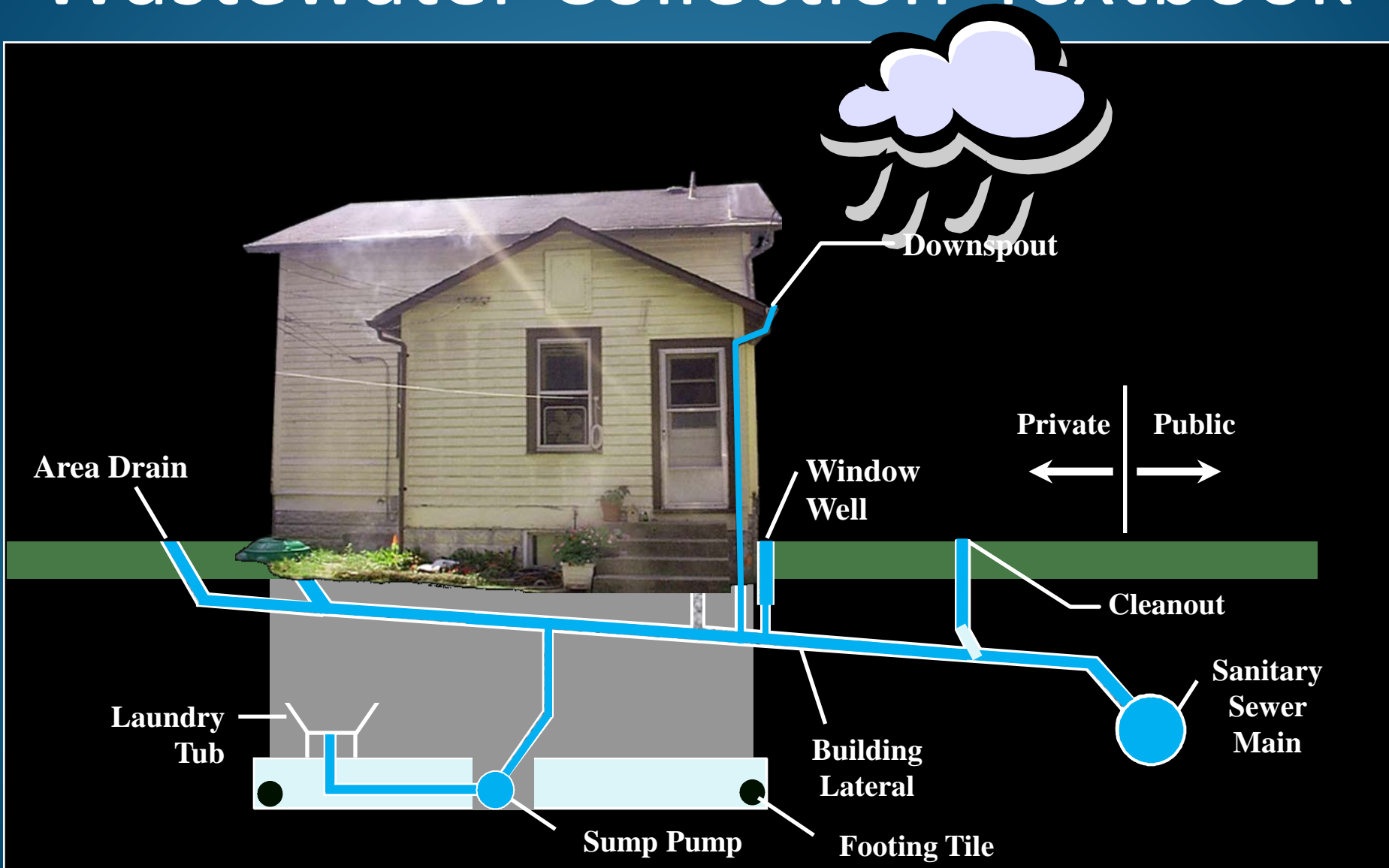

# Wastewater Collection- Real World

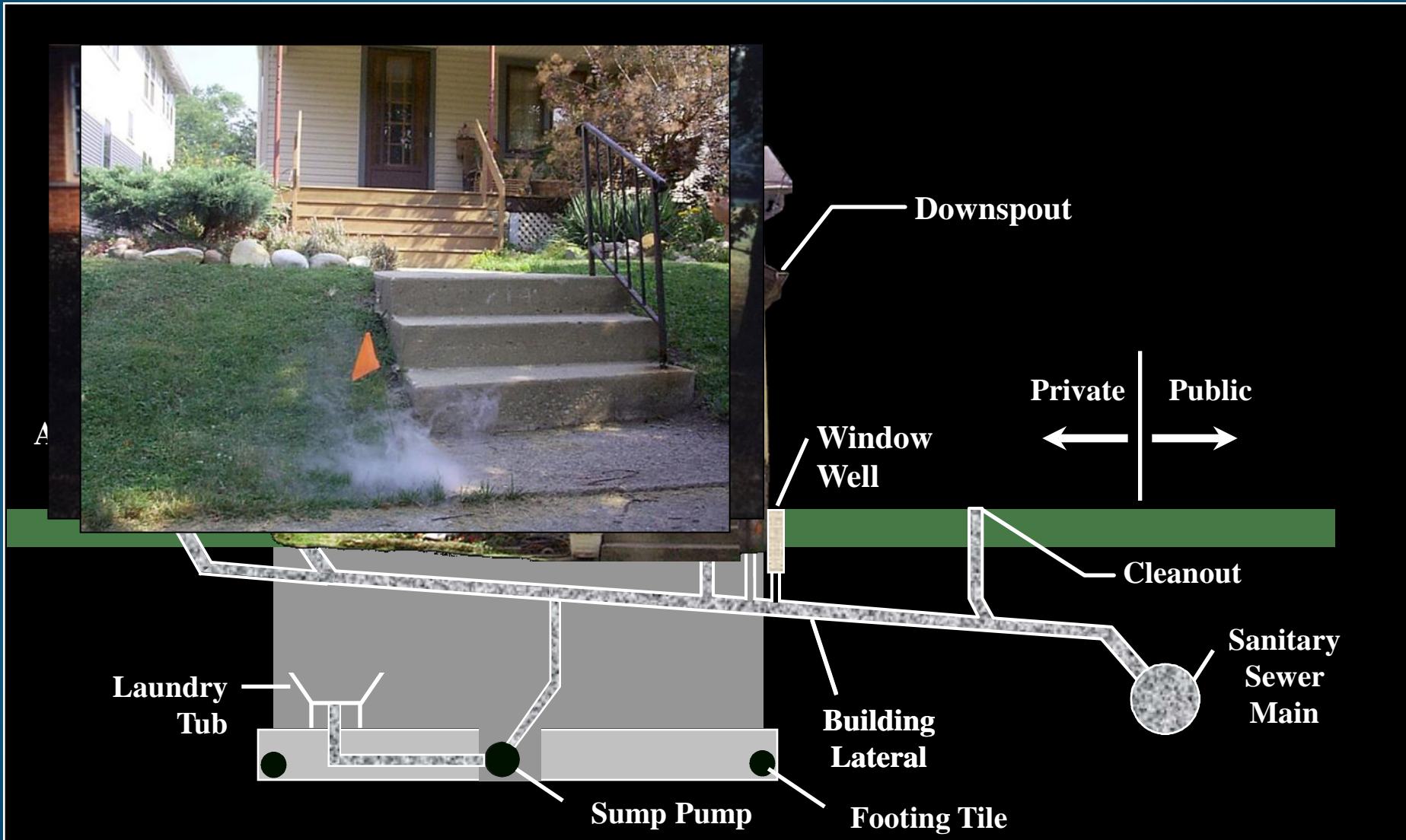

# Wastewater Collection- Real World

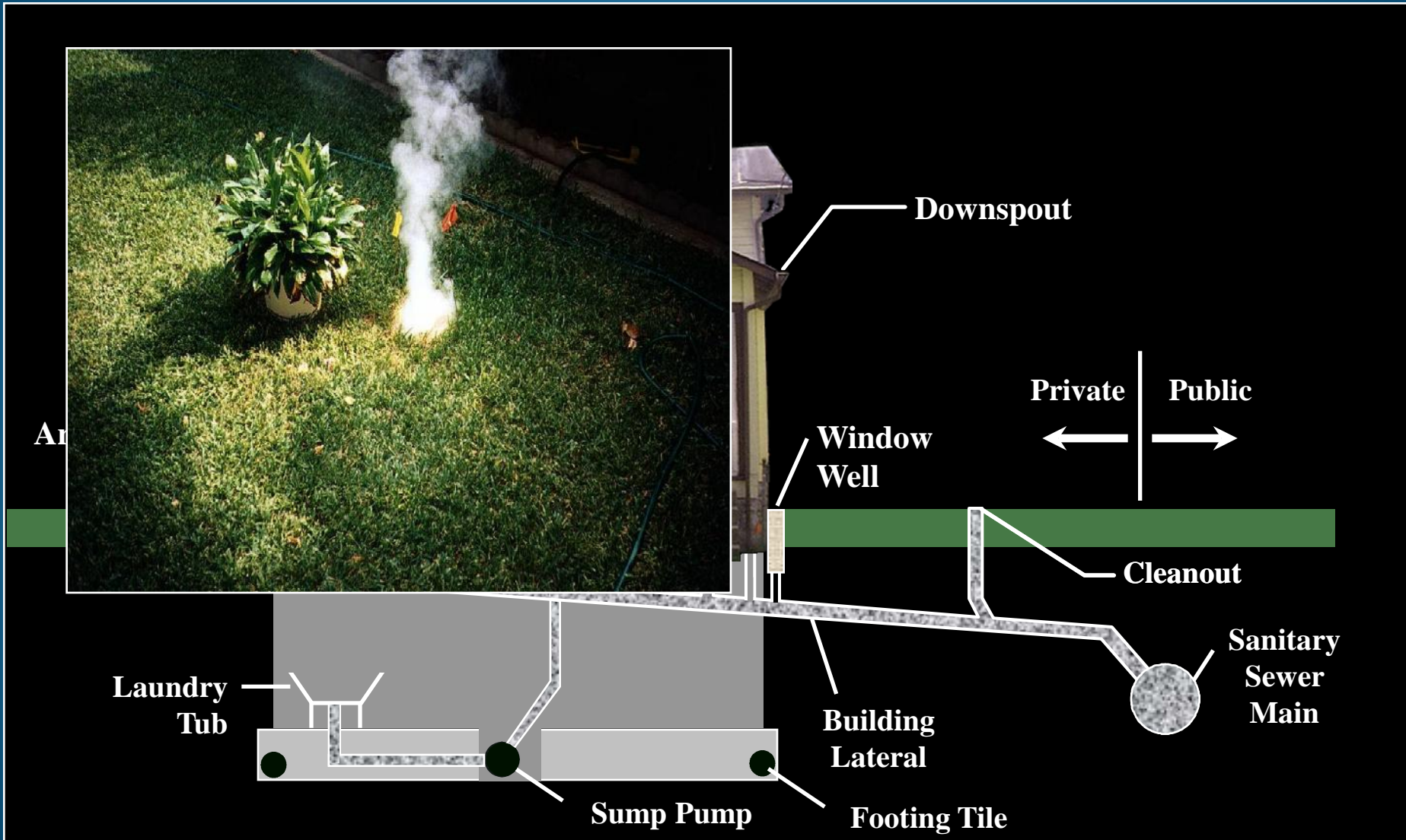

# Wastewater Collection- Real World



Downspout

A

Window well

Private

Public



Cleanout

Sanitary  
Sewer  
Main

Laundry  
Tub

Building  
Lateral

Sump Pump

Footing Tile

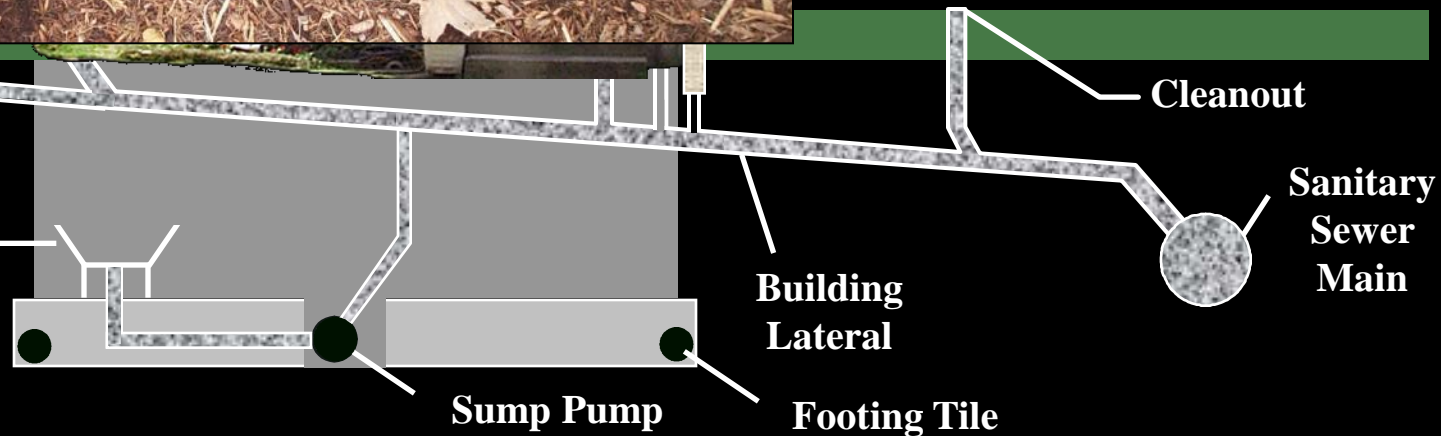

# Wastewater Collection- Real World

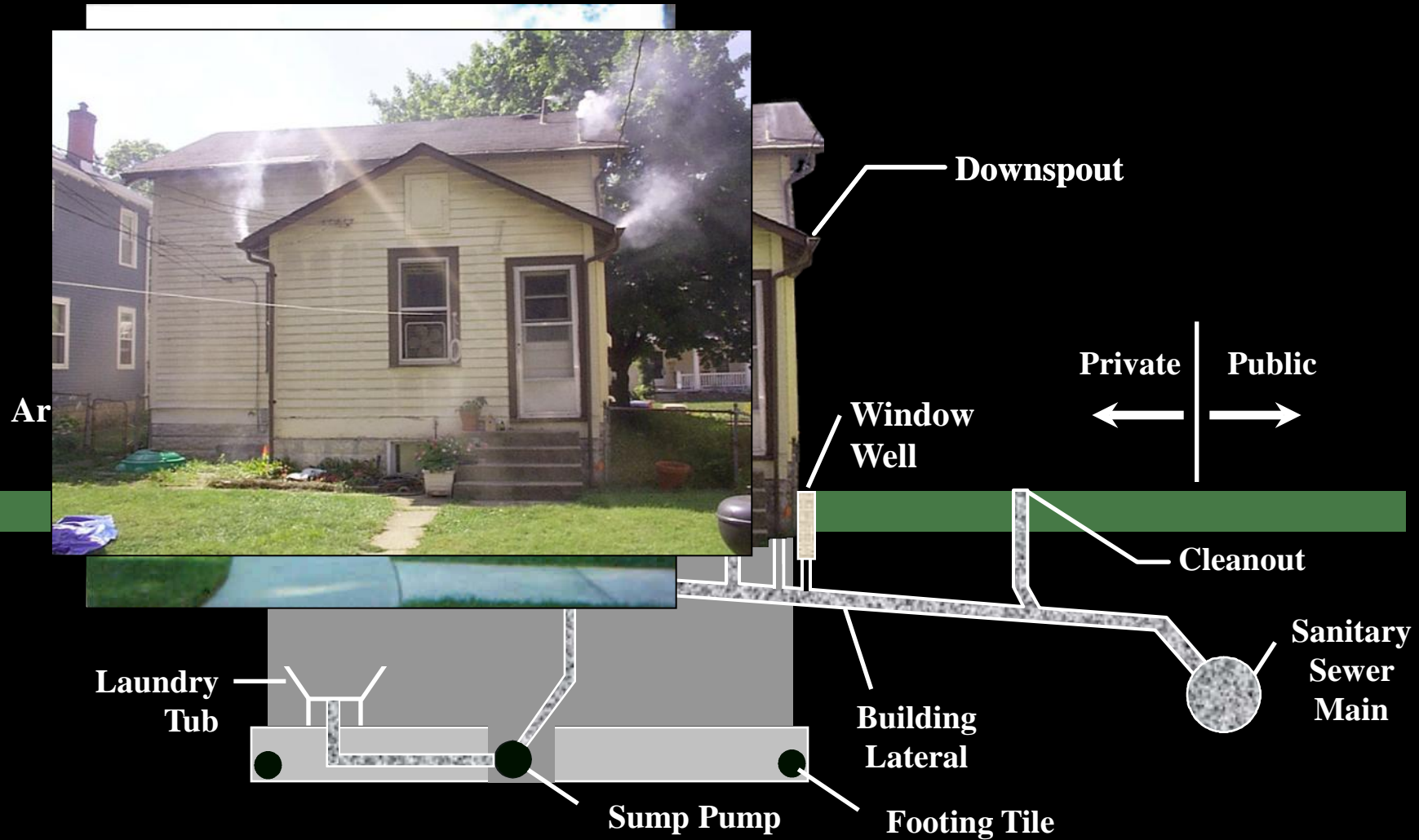



# Wastewater Collection- Real World

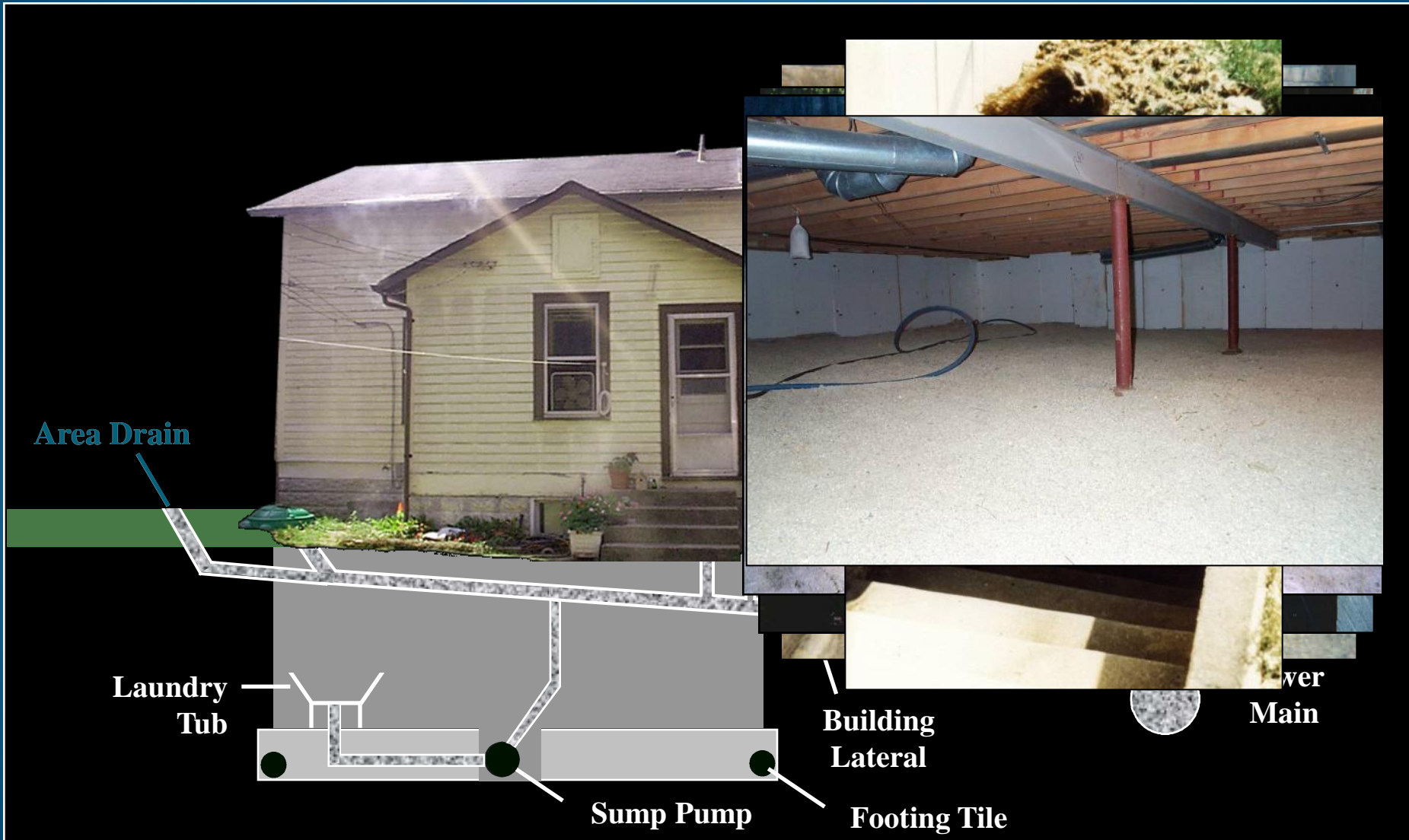

# Directly Connected Foundation Drain



Private      Public  
←                      →

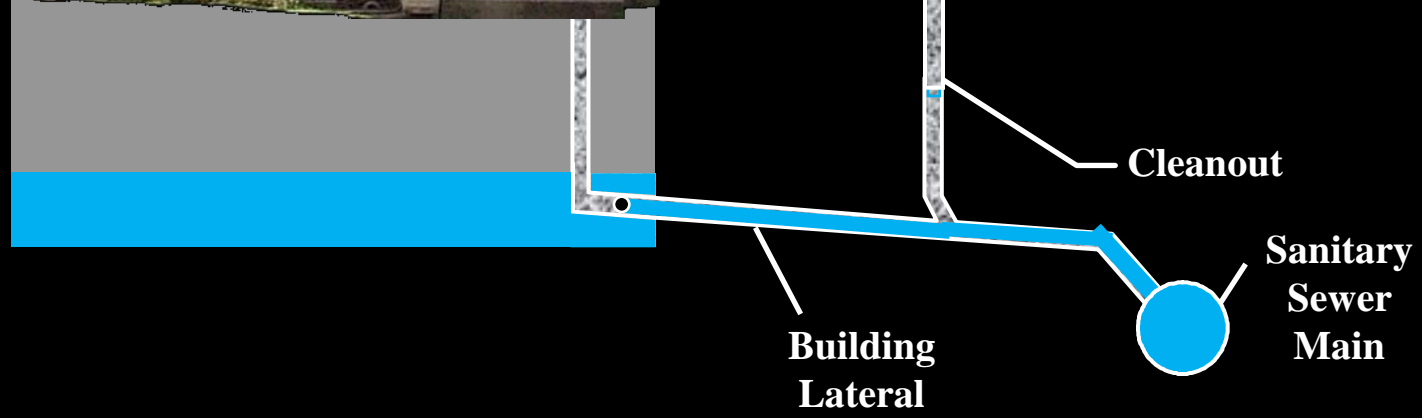

# Recent Flows to District WRP's

Serving Areas with Separate Sanitary Sewers

WRP	Dry-Weather Flow Month October 2013	Wet-Weather Flow Month April 2013	Peak Daily Flow April 18, 2013	Wet-Weather Peaking Factor	Wet-Weather Peak (gpcpd)
Egan	20.8 MGD	33.5 MGD	54.8 MGD	2.63	341
Hanover Park	6.3 MGD	14.0 MGD	27.5 MGD	4.36	486

# TRAINING OUTLINE

- Historical Perspective
- WMO Article 8
- Infiltration/Inflow Basics
- **Technical Guidance Manual**
  - **Definitions**
  - Short-Term Requirements
  - Private Sector Program
  - Long-Term Program

# Key Terms and Definitions

- **Public Sector Sewer**

- Portion of the sanitary sewer system owned / maintained by a public agency
- Typically includes all main sewers, manholes, and appurtenances
- May also include the service connection at the main sewer for each lateral sewer, and the lateral sewer from the main sewer upstream to the property line
- The portion of the sewer system that is considered public **will vary by agency**

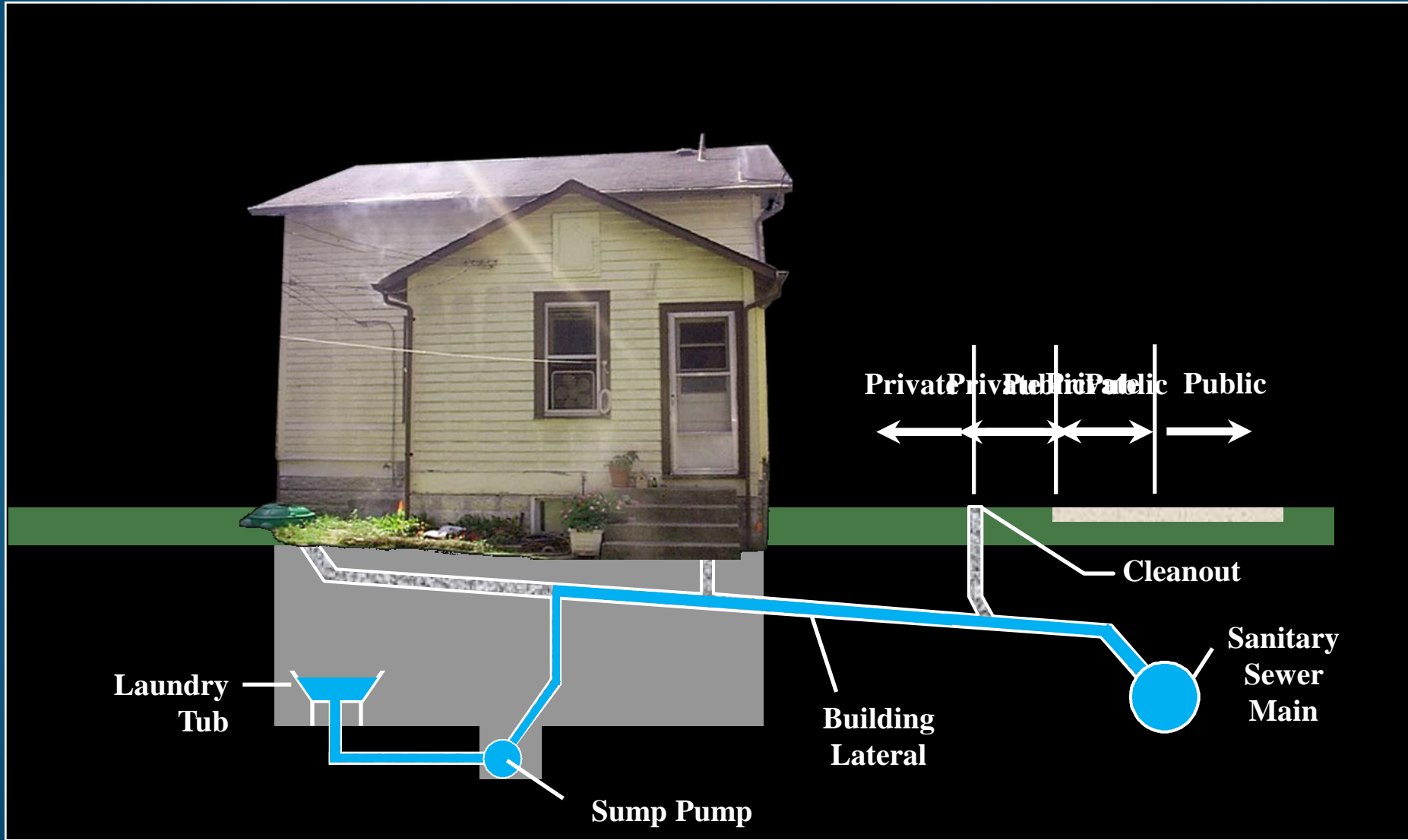

# Key Terms and Definitions

- **Private Sector Sewer**

- Portion of the sanitary sewer system owned / maintained by private owners
- Typically includes the service lateral from each building up to the public sewer, including the connection
- In cases where all sewers within the public right-of-way are considered public sewers, a lateral from the property up to the property line is treated as private sewer
- The portion of the sewer system that is considered private **will vary by agency**

# Key Terms and Definitions

- **Sanitary Sewer Overflow (SSO)**

- Any release or diversion of untreated sanitary wastewater from the sanitary sewer system **to a surface water, storm sewer or storm ditch or the ground** due to circumstances including but not limited to rain, snow melt, power outage, collapsed sewers, equipment failure, widespread flooding and/or pumping





# Key Terms and Definitions

- **Basement Backup (BB)**

- Discharge of sanitary wastewater into the lower level of a building caused by either a **blockage or collapse on the service lateral** from the building to the public sewer system or by **surcharging of the public sector sewer system**



# Key Terms and Definitions

- **Reportable Event**

- The Total number of events that must be reported to MWRD as part of the annual report required of all separate sanitary sewer system agencies. Reportable events include:
  - Wet-Weather Sanitary Sewer Overflows
  - Dry-Weather Sanitary Sewer Overflows
  - Basement backups caused by public sewer surcharging and blockages under either wet-weather or dry-weather conditions
- Reportable events do not include:
  - Basement backups caused by collapse or blockage entirely on the private service lateral

# Key Terms and Definitions

- **“High Priority” Defect**

- A defect that has a **low cost of removal to infiltration/inflow flow rate ratio** or that has a **high likelihood of causing sewer collapse or blockages** if not rehabilitated
- High priority defects will include all defects that are rated as either “4” or “5” under NASSCO sewer defect coding standards
- Storm sewer/sanitary sewer cross connections, building downspout connections, and open cleanout caps



# Key Terms and Definitions

- **Risk Based Criteria**

- Criteria for each asset in the sanitary sewer system that incorporates the **impact to public health and the environment, public disruption or expense** in the event of failure of that asset
- Criteria may include but not be limited to past frequency of emergency and preventive maintenance, depth, large diameter pipe, rear yard sewers, sewers located under creeks / streams / rivers or major highways / bridges and railroad tracks

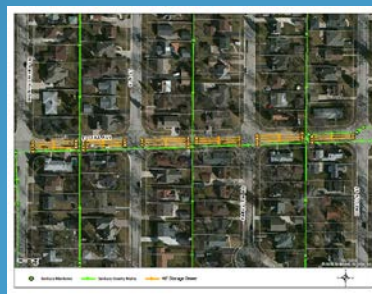
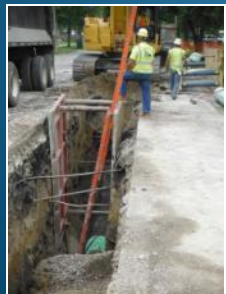

# Key Terms and Definitions

- **NASSCO Defect Coding Standards**

- National Association of Sewer Service Companies
- Developed in 2001
- Sewers (PACP®)
- Manholes (MACP®)
- Laterals (LACP®)



# TRAINING OUTLINE

- Historical Perspective
- WMO Article 8
- Infiltration/Inflow Basics
- **Technical Guidance Manual**
  - Definitions
  - **Short-Term Requirements**
  - Private Sector Program
  - Long-Term Program

# Short-Term Requirements (Article 804)

- Requirements
- Condition Assessment Prioritization
- Condition Assessment
- High Priority Deficiencies / Rehabilitation
- Auditing by MWRD



# Short-Term Program Requirements

- Within First Five (5) Years (July 2014 - July 2019)
  - Condition assessment of system (minimum 10%)
  - Undertake rehab work for high priority defects
  - Develop Long-Term Operation and Maintenance Plan (LTOMP)
  - Develop Private Sector Program (PSP)





# Condition Assessment Prioritization

- Satellite Entities Must Identify Priority Areas
  - Areas with SSOs and/or BBs - one or more per year
  - Areas upstream of SSOs and BBs
  - Sub-basins known to surcharge
  - Areas with excessive wet-weather flows and/or excessive lift station pumpage

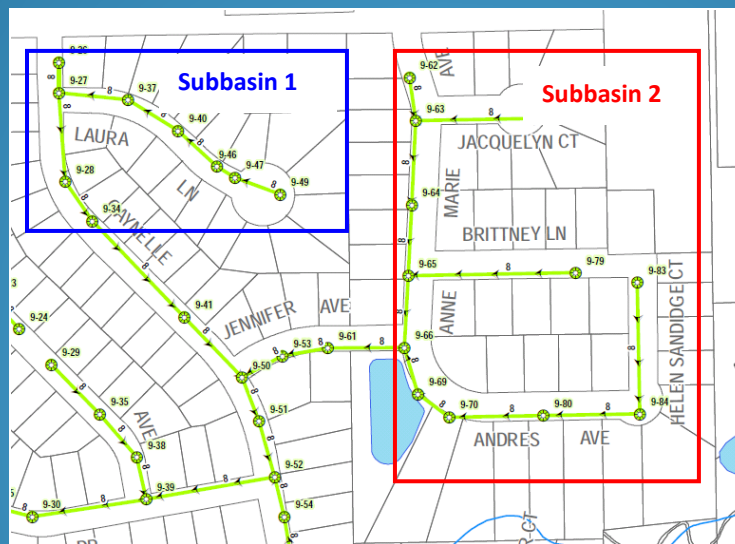

# Condition Assessment Prioritization

- Priority Areas (continued)
  - Areas with system deficiencies that could result in system failure
  - Other criteria defined by satellite entity

## Submittals/Requirements

- Condition Assessment Prioritization Form
- Map of high risk areas with Condition Assessment Prioritization Form
- NO LESS than 10% of the total system in 5 year program

# Wet-Weather Peaking Factors

- Optional Method for Condition Assessment Prioritization Based on Flow Metering
- Based on Wet-Weather Flow Monitoring Data
- Ratio of Peak Wet-Weather to Average Dry-Weather Flow
- Determine Dry-Weather Diurnal Flow
  - Select one week period isolated from rainfall
  - May also include permanent infiltration
- Establish Peak Flow in Response to Significant Storm Event(s)
  - For all storm events during flow monitoring period
  - Sustained peak flow for 60-minutes
  - Avoid storms less than 0.15-inches per hour

# Wet-Weather Peaking Factors

- Determine Wet-Weather Peaking Factors
  - Peak sustained flow divided by average daily flow for same time of day
  - Avoid storms less than 0.15 inches per hour
- Rank Sub-Basins in Descending Order
- Initiate Condition Assessment in Sub-Basins with Highest Peaking Factors
- Peaking Factors Greater than 4 for a 1-Year Design Storm Are Highly Likely to Have Excessive Infiltration/Inflow

# Average Dry-Weather Flow (ADWF)

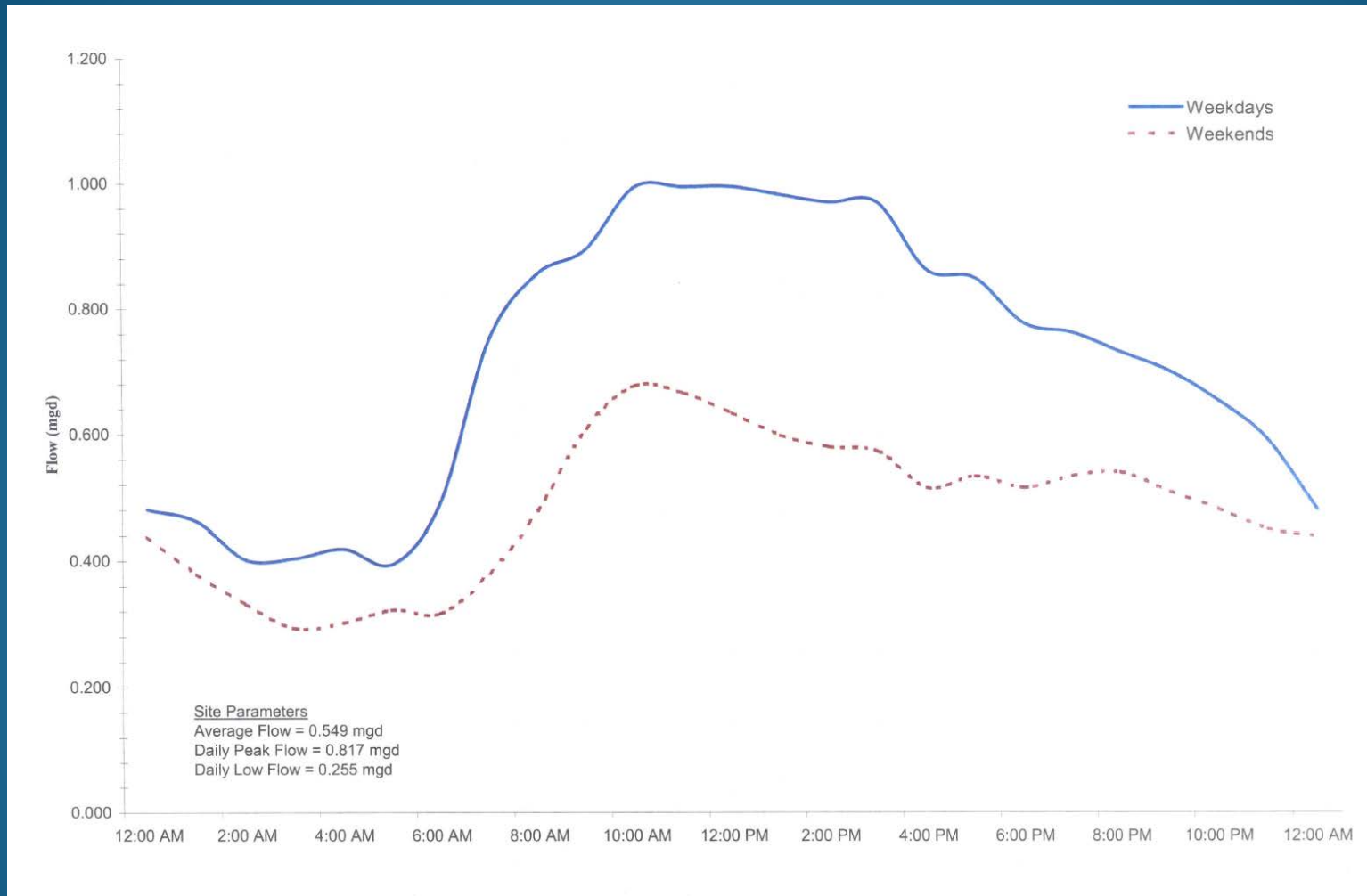

# Determination of Peak Excess Flow

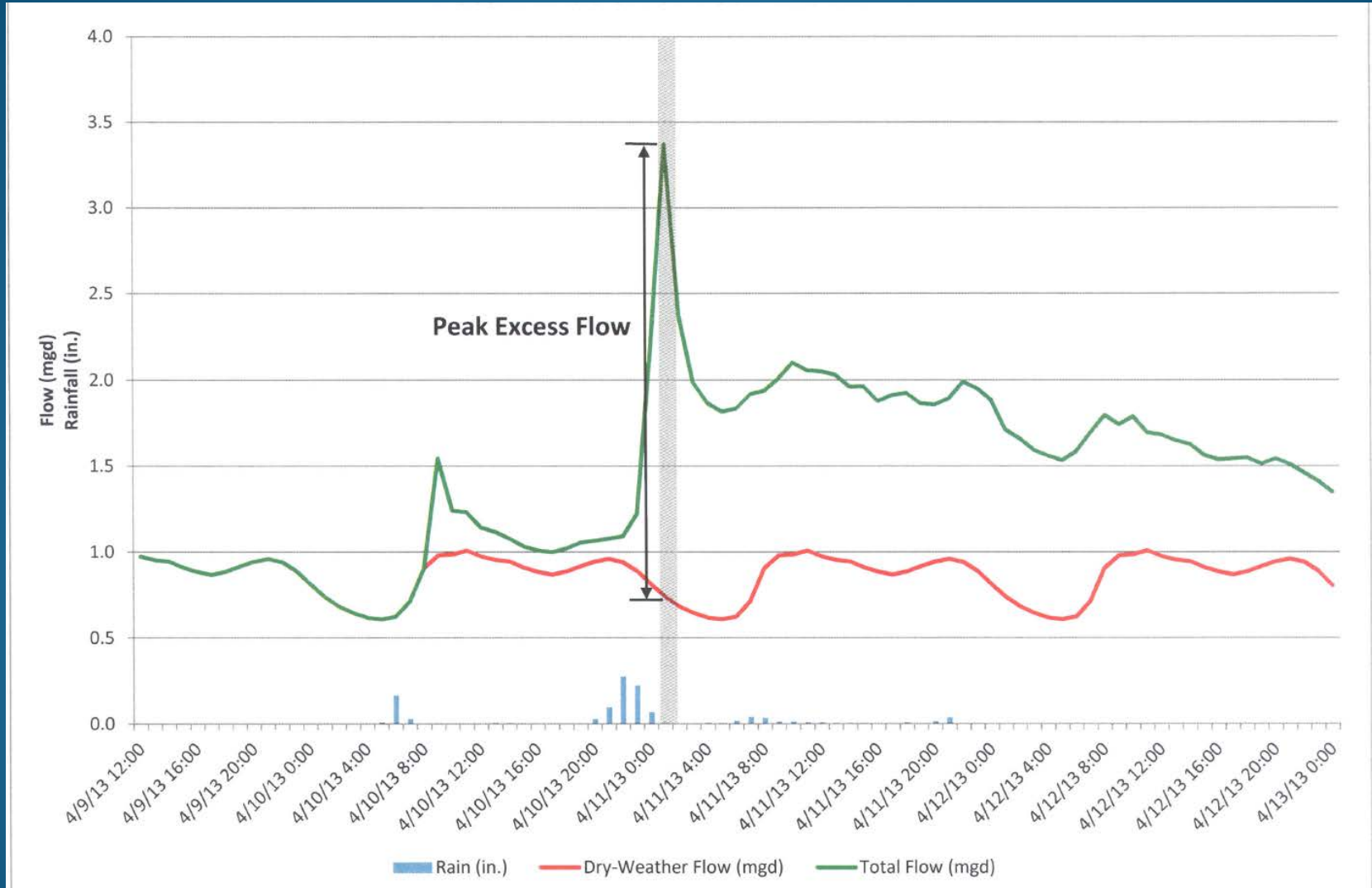

# Typical Basin Ranking - Wet-Weather Peaking Factors

Meter	Dry Weather Flow	1-Hr Peak Flow	Wet Weather Peaking Factor	Priority Ranking
	(mgd)	(mgd)		
G	0.65	19.5	30.0	1
O	0.60	17.7	29.5	2
Q	0.44	12.2	27.7	3
A	0.42	10.5	25.0	4
D	0.56	13.2	23.5	5
N	0.39	6.0	15.5	6
F	0.69	9.8	14.2	7
R	0.61	8.2	13.5	8
C	0.49	6.1	12.5	9
E	0.59	6.5	11.0	10
F	0.55	5.5	10.0	11
H	0.70	5.6	8.0	12
J	0.62	4.8	7.7	13
B	0.55	4.1	7.5	14
E	0.61	3.1	5.0	15

# Condition Assessment Prioritization Form

## CONDITION ASSESSMENT PRIORITIZATION FORM INFILTRATION & INFLOW CONTROL PROGRAM

Satellite entities must use this form to explain the criteria used to define which portions of their sanitary sewer system are “high risk”. Once the MWRDGC has reviewed and approved a satellite entity’s Condition Assessment Prioritization, this form does not need to be resubmitted, unless the satellite entity wishes to modify the criteria it uses to define “high risk” sewers.

Type of Area	Present In System (yes/no)	Prioritization Criteria	Linear Feet of High Priority Sanitary Sewer to be Assessed in Short Term <sup>(1)</sup>
Areas with SSOs and/or BBs	Yes	High risk areas have had SSOs and/or BBs reported during 1-year rain events and/or dry weather.	50,000
Areas upstream of SSO/BB areas	Yes	Not high risk. All have been lined in last 15 years. All manholes have been inspected and those allowing I/I have been rehabilitated in last 15 years.	0
Sub-basins known to surcharge	Yes	High risk areas have surcharged in 1-year rain event.	50,000 <sup>(1)</sup>



# Condition Assessment Prioritization Form

Areas with excessive wet weather flows, other than those listed above	No	Same as areas with SSOs and BBs. No flow metering has been performed to identify other areas with excessive wet weather flows.	0
Areas with excessive lift station pumpage	Yes	Not high risk. Public sewer in area tributary to pump station has been lined over past 10 years. Excessive lift station flows due to private sector I/I.	0
Areas with deficiencies that could result in system failures	Yes	H2S corrosion evident in 15" main along Cambridge Street between First Ave. and Eighth Ave. This is high priority.	4,400
Other (describe) <sup>(2)</sup>	Yes	Odor complaints submitted every week in dry weather along Gardner Street	2,000
Total length of public sanitary sewers (feet):			500,000
Total length of High Priority sanitary sewer to be assessed in short term (feet):			106,400
Percentage of public sanitary sewer system to be assessed in short term:			21.28%

<sup>1</sup>Include sewers inspected under pre-IICP condition assessment, if applicable.

<sup>2</sup>Attach additional sheets if necessary to describe other types of areas and prioritization criteria

**Attachment:**

- Map of High Risk Sewers
- Sanitary Sewer System Description and Inventory

**Prepared by:**

**Signature:** \_\_\_\_\_ **Date:** February 17, 2016

**Printed Name:** \_\_\_\_\_ **Title:** \_\_\_\_\_

**Telephone:** \_\_\_\_\_ **Email:** \_\_\_\_\_

# Condition Assessment Requirements

- In All High Risk Areas
  - Televising all public sewer lines
  - Inspect all manholes
  - Inspect all lift stations
  - Smoke test all public sewer lines
  - Dye test sewers in high risk areas where:
    - Smoke test finds possible cross-connections with storm system
    - Sewer lines cross under areas subject to ponding
    - Downspouts discharge underground



# Condition Assessment Requirements

- Follow-up external property inspections of high risk areas to identify discharge location of downspouts piped underground that did not smoke
- Conduct in Accordance with NASSCO Standards
  - Non-NASSCO program must be approved by MWRD
  - Must be submitted for approval by March 1, 2016



# Condition Assessment Standardization

- Uniform Inspection Standards Based on Current Technology Coupled with Uniform Classification of Main Sewer, and Manhole Defects Under the NASSCO Defect Coding System
- Uniform Reporting, and Assessment of Compliance with MWRD Requirements
- Consistency in the Development of Short-Term Program Rehabilitation Costs
- Equitability Among Satellite Entities

# Condition Assessment Standardization

- Credit for Those that Have Already Conducted Investigation / Rehabilitation Work
- Standardization of Rehabilitation Work Eligible for IEPA SRF Funding, and Possible MWRD Funding
- Consistency in Annual Reporting to MWRD of Completed Rehabilitation

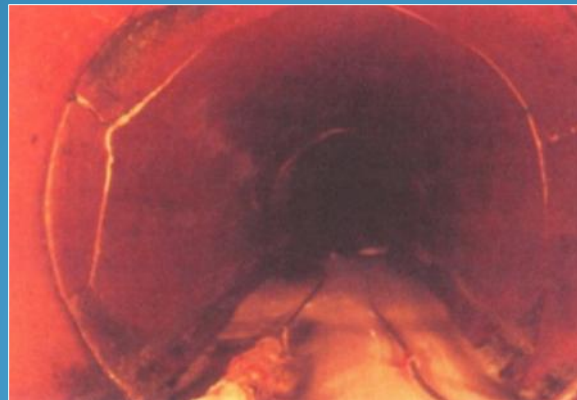

Fracture Multiple (FM)

# Closed Circuit Television Inspection (CCTV)

- Operations Certified in NASSCO PACP
- Camera
  - Color pan and tilt
  - Turn at right angle to pipe axis
- ≤ 30 Feet Per Minute, Stop at Each Lateral Connection
- Data
  - Defect attribute data delivered in format compatible with GIS (Recommended)
  - Defect location(s) measured from upstream manhole
  - Digital audio, video and photographs linked in database to correct line segment



# Manhole Inspection

- Compliant with NASSCO MACP Defect Coding
- Full Descent Inspections
  - Typically for manhole  $\geq$  12-feet deep
  - Significant Debris / structural conditions
  - Need accurate rim and invert elevation difference
- “Pole Camera” Inspections
  - Typical for manholes  $\leq$  12-feet deep



# Manhole Inspection

- Surface Inspections
  - Primarily for determining if full descent/  
Pole camera inspection required
  - Most effective for identifying defects in  
top portion of manhole
  - NASSCO Level 1 Procedures
- Data
  - Photographs / video of defects linked to  
GIS database (Recommended)
  - Compatible with GIS database
  - Mapping grade (minimum) location

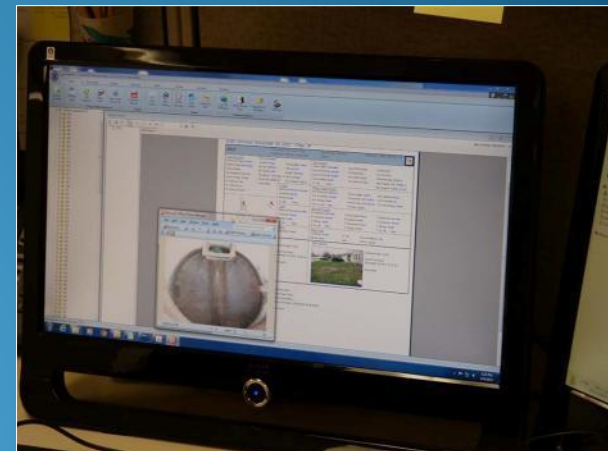



# Lift Station Inspection

- If Used for Flow Monitoring Location
  - Calibrate with fill and draw OR
  - Force main pressure meter
- Data
  - Compatible with GIS database (Recommended)
  - Mapping grade (minimum) locations
  - Video /photo graph linked to GIS database (Recommended)



# Smoke Testing

- Public Relations Before Testing
- NASSCO Performance Specification for Testing - 2010
- Dual Blowers in Adjacent Manholes
  - Drive smoke through soil seams to identify indirect cross connections, deep mainline defects, service lateral defects
  - Not necessary to use adjacent manholes if manhole spacing is  $\leq 400$  feet
- Identify “Suspect Sources” that Did Not Smoke - Follow-up Dye Testing
  - Down spouts underground
  - Driveway drains
  - Area drains

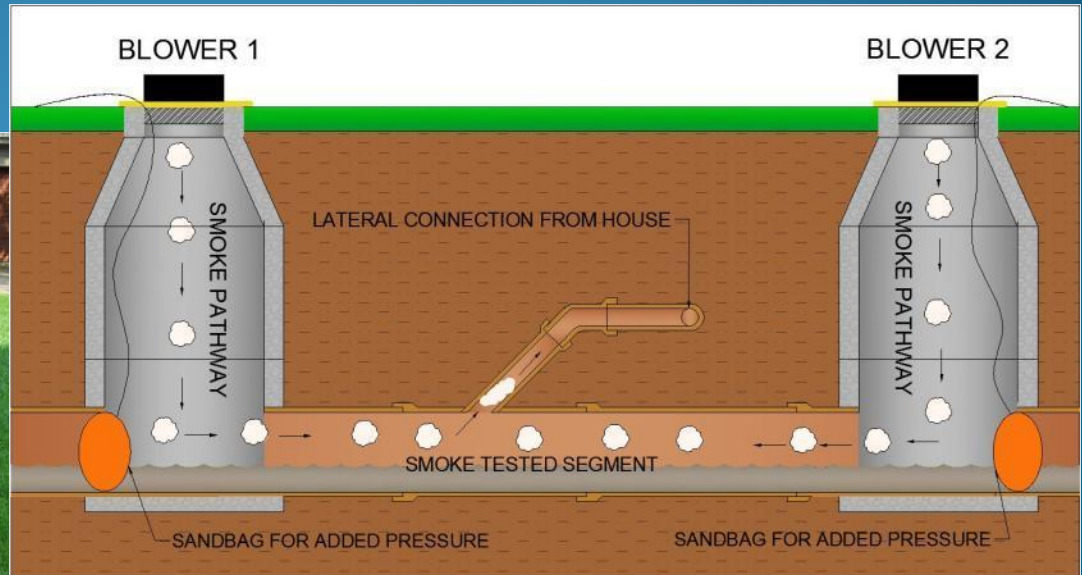
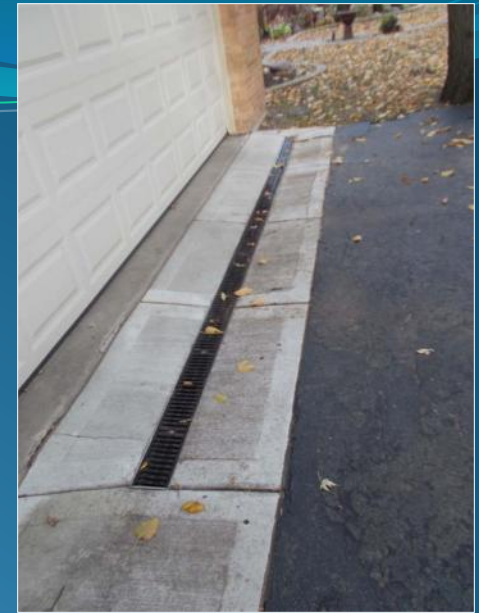
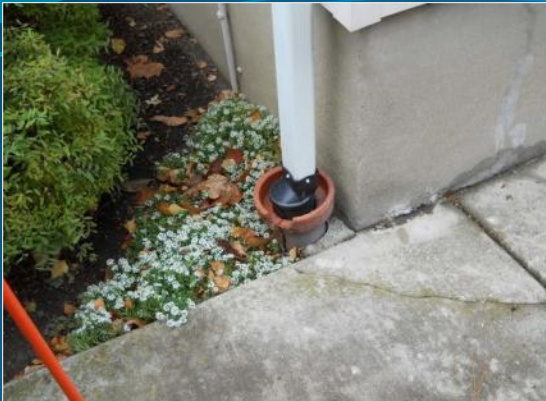



# Condition Assessment - Property Inspection

- External Inspection
  - Normally conducted during smoke testing
  - Required for connected downspouts and defective cleanouts
  - May require dye test



# Dye Testing

- Follow-up from Smoke Testing to Identify Specific Location of Cross-Connections
- Plug Storm Sewer / Storm Ditch for Indirect Cross-Connections
  - Depth / velocity of sanitary sewer before and after flooding
  - Service Lateral crossing storm sewer / storm ditch most common defect
  - CCTV in conjunction with dye testing to confirm defect location(s)

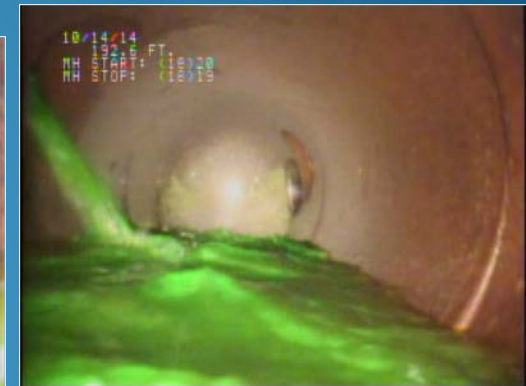
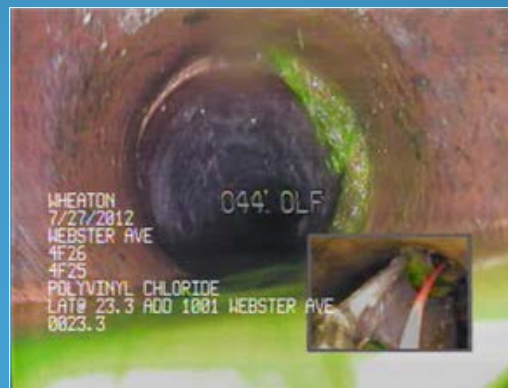
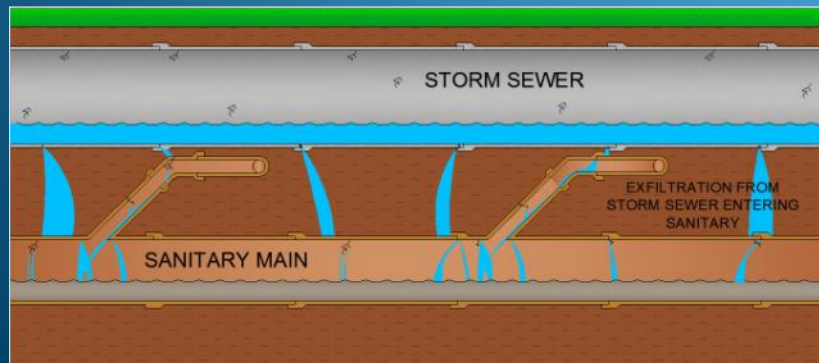

# Dye Testing

- Without Plugging for
  - Downspout piped underground that did not smoke
  - Driveway drains / area drains that did not smoke
- Data
  - Digital video / photographs linked to GIS database
  - Mapping grade (minimum) location for defects



# Sewer System Inspection/Condition Assessment

- Alternative Inspection Methods (Not required by MWRD)
  - Electric current leakage testing (proprietary technology)
    - Alternative to CCTV on prioritization tool for follow-up CCTV
    - Identify defects not visible on CCTV
    - Non-conductive pipe materials
    - Provides quantifiable measure of pipe leakage potential
    - Normally quicker inspection than CCTV
    - Defects below flow line can be detected
    - Defects in lined pipe can be detected
    - No visual image or PACP rating

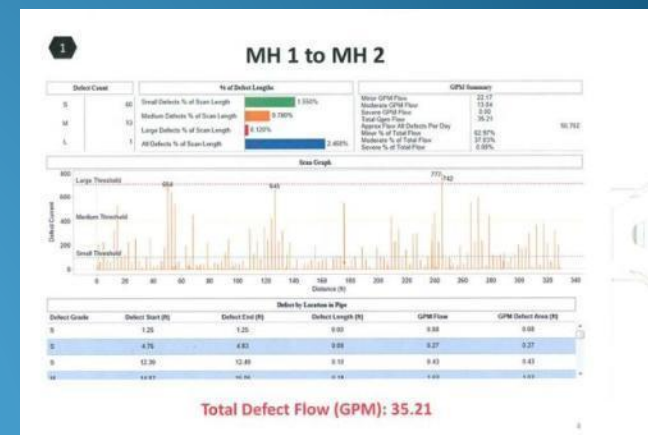



# Sewer System Inspection/Condition Assessment

- Acoustic Emissions Testing (AET)
  - Pressure pipes force mains, siphons
    - Pipe must be full during inspection
    - Acoustic sensors require entry / exit points
  - Gravity sewer
    - Surface signal between manholes from surface
    - Faster, less expensive than CCTV, conducted from surface
    - Locates blockages
    - Follow-up CCTV required
    - More effective for smaller pipes



# Condition Assessment – Property Inspection

- Internal Inspection
  - Not required as part of Short Term Requirements but encouraged
  - Used to identify:
    - Storm sump connections
    - Combination sump connections
    - Diverter valves
    - Unsealed sanitary sumps
  - May require follow-up dye tests to confirm connectivity



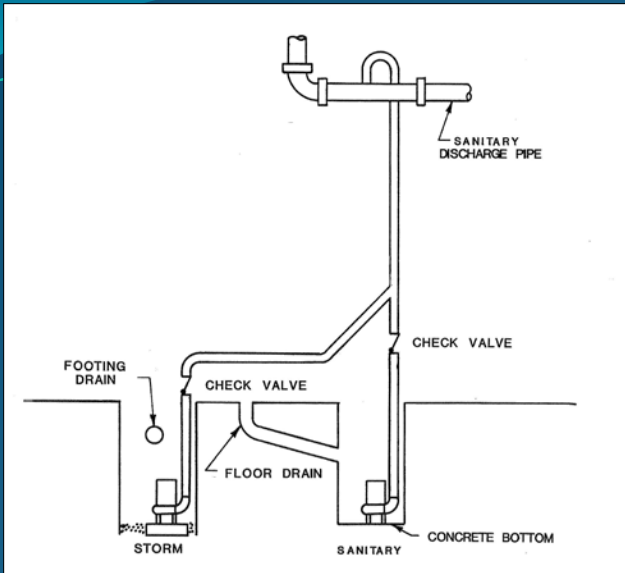

Storm Sump Connected to Sanitary Sewer

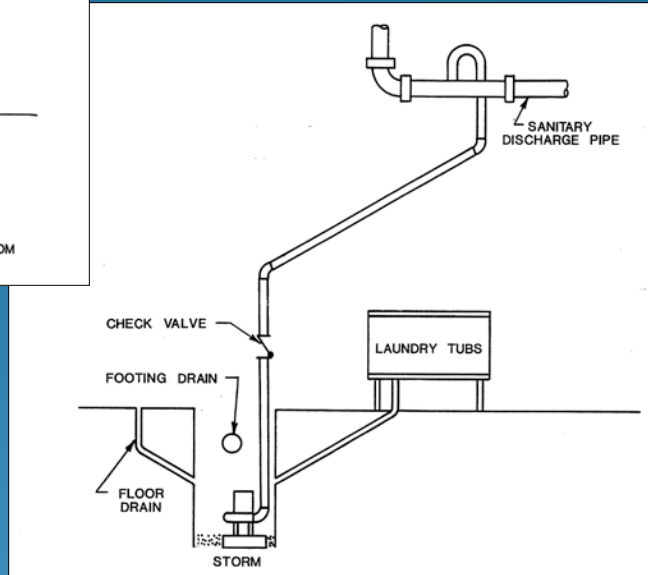

Combination Storm Sump

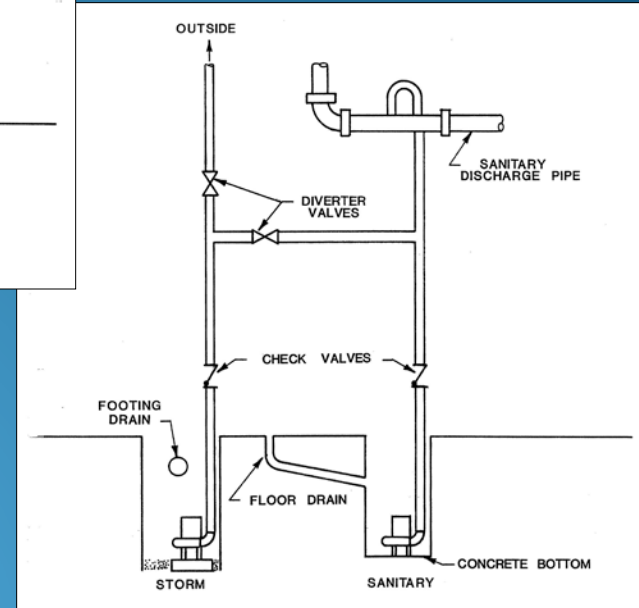

Storm Sump with Diverter Valve

# “Credit” for Prior Condition Assessment Activities

- Within Five Years and Utilized NASSCO Defect Coding Standards OR
- Submit Details of Existing Defect Coding Standards to MWRD for Approval
- Submit Documentation with Short-term Requirements Annual Summary Report
  - Dates of inspection activities
  - Name / certificate of individual performing assessments
  - Inspection findings

# “Credit” for Prior Condition Assessment Activities

- Include Documentation of Completed Rehabilitation as Result of Defects Identified in Pre-IICP Inspection
- Special Waiver for CCTV Work Conducted Prior to 2010 as Part of CIPP Lining in High Risk Areas
  - Still required - manhole inspection, smoke testing, dye
  - Still required - CCTV same footage - other high risk areas
  - Submit waiver request with Condition Assessment Prioritization Form
  - Show rehabilitated areas, unrehabilitated areas to be televised, smoke and dye tested

# High-Priority Deficiencies

- Mainline Sewer
  - NASSCO Grade 4 and 5 defects
- Manholes
  - NASSCO Grade 4 and 5 defects
- Cross-Connections
  - Direct storm-to-sanitary connections
  - High-flow indirect connections
- Private Sector Deficiencies
  - Low-Cost High Priority deficiencies – downspouts and defective cleanouts
- Form basis for a Capital Improvement Plan (CIP)

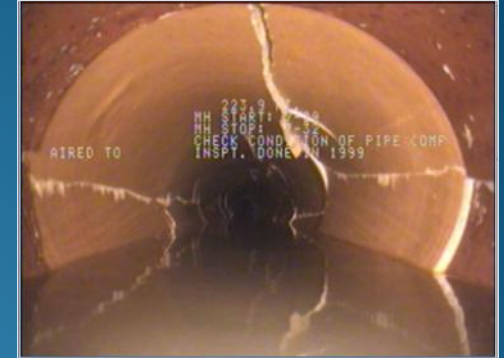

# High Priority Mainline Defects

<u>Structural</u>	<u>Grade</u>
Crack Hinge	4-5 (depends on location)
Fracture Multiple	4
Fracture Hinge	4-5 (depends on location)
Broken	5
Collapse	5
Deformed	4-5 (depends on severity of deformation)
Hole	4-5
Surface Aggregate Missing	4
Reinforcement Visible	5
Reinforcement Corroded	5
Missing Wall	5
Brick Work Missing	4
Dropped Invert (brick)	5

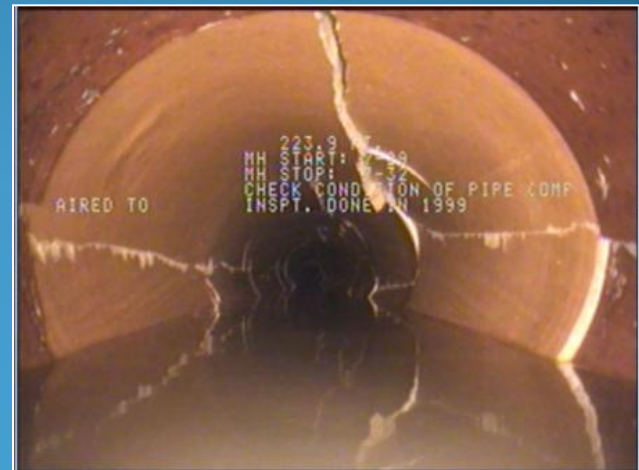

# High Priority Mainline Defects

<b>O&amp;M</b>	<b>Grade</b>
Deposits (all) 20-30%	4
Deposits (all) >30%	5
Root Ball Barrel	5
Root Ball Lateral	4
Root Ball Connection	4
Infiltration Runner	4
Infiltration Gusher	5
Obstacles/Obstructions (all) 20-30%	4
Obstacles/Obstructions (all) > 30%	5

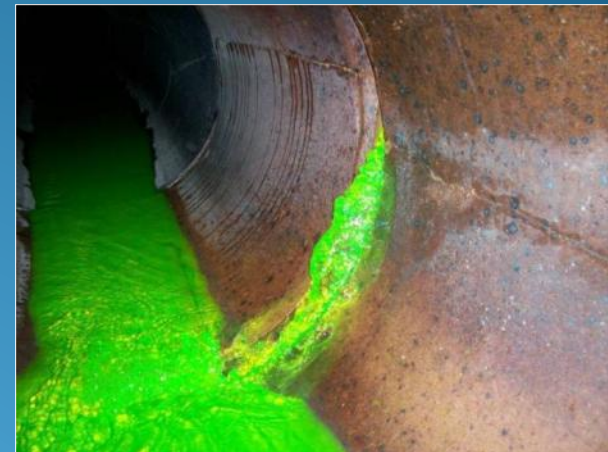



# High Priority Manhole Defects

## Level 1

Cover Type

Cover Condition

Frame Condition

Frame Offset Distance

Frame Seal Inflow

Chimney I/I

Additional Component Information

## Condition

Vented/Pick Holes

Cracked, Broken, or Missing

Cracked, Broken, or Missing

> 3-inches

Gusher, Runner, Dripper

Gusher, Runner, Dripper

Note significant structural or I/I observation

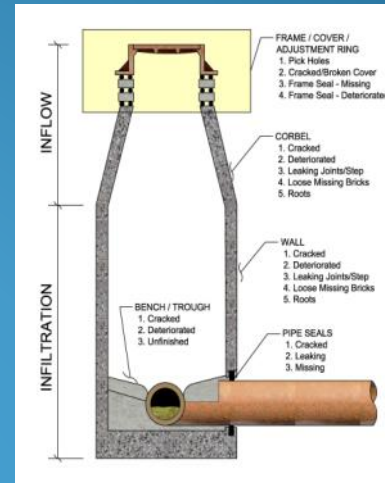

# High Priority Manhole Defects

## Level 2 Structural

Fracture Multiple

Broken

Collapse

Deformed

Surface Aggregate Missing

Reinforcement Visible

Reinforcement Corroded

Missing Wall

Brick Work Missing

## Grade

4

5

5

4-5 (depends on severity of deformation)

4

5

5

5

4

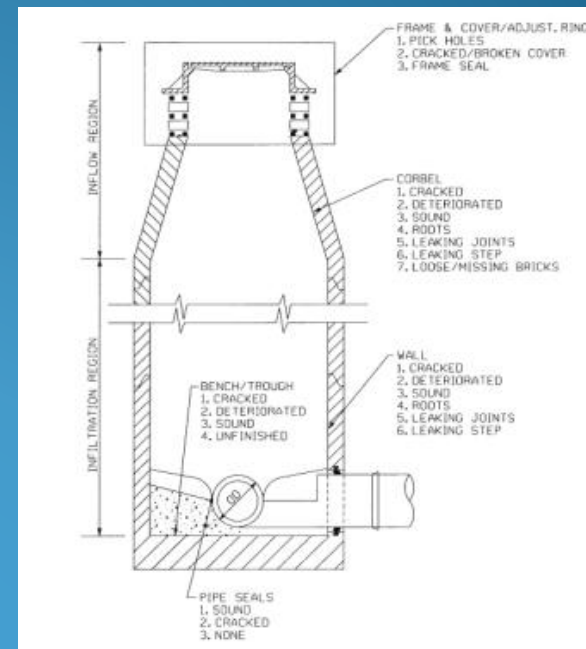

# High Priority Manhole Defects

<u>Level 2 O&amp;M</u>	<u>Grade</u>
Root Ball Barrel	5
Root Ball Lateral	4
Root Ball Connection	4
Infiltration Runner	4
Infiltration Gusher	5
Obstacles/Obstructions (all) 20-30%	4
Obstacles/Obstructions (all) > 30%	5
Root Ball Barrel	5

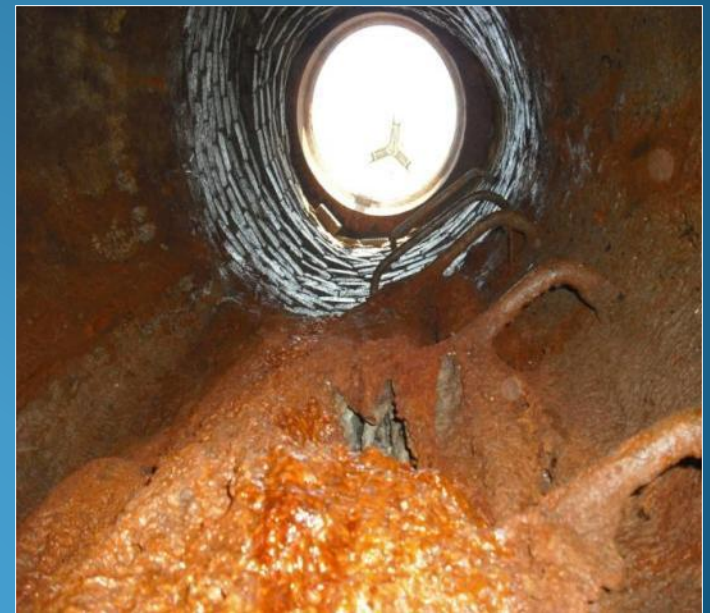

# High-Priority Rehabilitation

- Manhole and Mainline Sewer
  - Rehab must be initiated within 3 years of identification OR
  - Must be included in Capital Improvement Plan (CIP)
- Cross-Connections with Storm Sewer
  - Many include service lateral / storm sewer ditch crossing
  - Rehab within 1-year of identification
- Private Sector
  - Directly connected downspouts, improperly disconnected downspouts, cleanout caps addressed within 1 year of identification
  - Remainder can be addressed in Long-Term Program



# High-Priority Rehabilitation

## **STATUS OF HIGH PRIORITY DEFICIENCIES FORM INFILTRATION & INFLOW CONTROL PROGRAM**

Satellite entities must use this form to track the status of high priority deficiencies that are not corrected during the reporting year in which they are identified. Deficiencies in the public sewer system as well as the private sewer system must be reported on this form. The CIP should correlate to projects listed under “Means of Correction”. Satellite entities may attach additional pages, or may generate their own tables showing the status, though any such tables must have the same column headings indicated on this form. If high priority deficiencies identified during pre-IICP condition assessments (if applicable) have not been addressed, include them on this form.

Are additional pages describing deficiencies attached?       Yes       No

# High-Priority Rehabilitation

**ONE YEAR DEFICIENCIES** (*direct and indirect cross connections, downspout connections, open or defective cleanout caps*)

<b>Deficiency ID</b>	<b>High Priority Deficiency Type</b>	<b>Date Identified</b>	<b>Anticipated Correction Date</b>	<b>Actual Correction Date<sup>(1)</sup></b>	<b>Means of Correction</b>	<b>MWRD Permit Number<sup>(2)</sup></b>
DS_935_ELM	Downspout	7/19/2015	5/1/2016	3/19/2016	Cut and plug w/ concrete cap	n/a
DS_826_MAPLE	Downspout	7/25/2016	5/1/2017	Pending	Cut and plug w/ concrete cap	n/a
CO_325_N_MAIN	Cleanout - missing	7/25/2016	5/1/2017	Pending	New cap	n/a
CO_941_ELM	Cleanout - broken	7/27/2015	5/1/2016	2/16/2016	New cap	n/a
DXC_SANMH_4-36	Direct X-connect.	8/17/2015	5/1/2016	4/19/2016	Plug and connect inlet to storm	NRI 16-6073
IXC_266_S_LINCOLN	Indirect X-connect.	9/16/2015	7/1/2016	8/20/2016	Lined lateral	n/a
IXC_104_S_MAIN	Indirect X-connect.	9/16/2016	6/1/2017	Pending	Point repair on storm sewer	n/a

# High-Priority Rehabilitation

<b>THREE YEAR DEFICIENCIES</b> ( <i>high priority manhole and mainline defects</i> )						
<b>Deficiency ID</b>	<b>High Priority Deficiency Type</b>	<b>Date Identified</b>	<b>Anticipated Correction Date</b>	<b>Actual Correction Date<sup>(1)</sup></b>	<b>Means of Correction</b>	<b>MWRD Permit Number<sup>(2)</sup></b>
MH_9-22	MH – collapsing	8/15/2015	10/30/2016	9/16/2016	Replaced manhole	NRI 16-6275
MH_10-55	MH – missing bricks	8/21/2016	5/30/2017	Pending	Structural liner	n/a
MH_10-86	MH – detached frame	9/3/2015	5/30/2017	Pending	New frame and chimney seal	n/a
3-65:3-64_123FT	Mainline – collapse (PACP5)	10/15/2015	10/30/2016	9/16/2016	Point repair	NRI 16-6276
9-06:9-05_27FT	Mainline – hinge fracture (PACP5)	10/30/2016	5/30/2017	Pending	CIPP liner	n/a

- (1) Entries in this column will all be “Not Applicable” in the first Annual Report, but will contain actual completion dates in subsequent reports as repair work is performed.
- (2) Enter the permit number once it is issued, if a permit is required for the work.

# High-Priority Rehabilitation

**Prepared by:**

**Signature:** \_\_\_\_\_ **Date:** February 15, 2017

**Printed Name:** \_\_\_\_\_ **Title:** \_\_\_\_\_

**Telephone:** \_\_\_\_\_ **Email:** \_\_\_\_\_

Page 1 of 1



# Short Term Requirements Annual Report Form

## SHORT TERM REQUIREMENTS ANNUAL SUMMARY REPORT INFILTRATION & INFLOW CONTROL PROGRAM

**Reporting Period:** January 1<sup>st</sup> to December 31<sup>st</sup>, 2015

**Satellite Entity:** City of Highland Ridge

**Latest version of sanitary sewer atlas is dated:** November 2013

**1. Condition Assessment Investigation & Rehabilitation of High Risk Sewers:** (reporting year only, unless otherwise noted)

A. (Complete for first full year of IICP only) To complete the Condition Assessment; is credit requested for prior documented work?

No       Yes → Submit documentation of previous work and summarize in 1.B.

B. Public Sector Investigation (attach map showing where investigation was performed):

Inspection Activity	Linear Feet or Number	% of System	% Cumulative <sup>1</sup>
CCTV	91,000	18.2	46.5
Smoke Testing	70,000	14.0	25.0
Dye Testing	3,200	0.6	0.6
Manholes	460	23.0	45.0
Lift Stations	8	100.0	100.0

# Short Term Requirements Annual Report Form

C. Public Sector High Priority Deficiencies: (submit a Status of High Priority Deficiencies Form and CIP for those not corrected)

	Main Line	Manhole	Appurtenances	X-Connection
Identified	4	5	0	3
Corrected <sup>2</sup>	3	3	0	1

D. Private Sector Investigation:

Number of Properties	% of Total System	Internal	External	Int. & Ext.
325	2.5	220	65	40

# Short Term Requirements Annual Report Form

## E. Private Sector I/I Sources:

	Identified	Corrected	Cumulative Total Remaining
Downspout <sup>3</sup>	2	1	1
Cleanout with Defective/Missing Cover <sup>3</sup>	3	2	1
Area Drain	3	0	3
Storm Sump w/divert valve	2	0	2
Storm Sump to Sanitary	7	3	4
Combination Sump	3	0	3
Unsealed Sanitary Sump	2	0	2
Window Well Drain	5	2	3
Foundation Drain	4	0	4
Lateral	32	0	32
Other:	0	0	0

<sup>1</sup>Include prior years, dating back to first year for which condition assessment credit applies

<sup>2</sup> Submit a Status of High Priority Deficiencies Form and Capital Improvement Plan (CIP) for identified deficiencies not corrected during the reporting year.

<sup>3</sup> Submit a Status of High Priority Deficiencies Form for identified deficiencies not corrected during the reporting year

# Short Term Requirements Annual Report Form

## **2. Narrative Description of Progress Made Towards Private Sector Program Development:**

Two pilot subdivisions – Meadow Ridge and Willow Glen – have been selected to start a building inspection program to identify illegally connected sump pumps. Approximately 325 properties in these two study areas have been inspected, as noted above. The city has implemented an incentive program to subsidize the cost to homeowners if they voluntarily disconnect their illegal sumps. The city council is currently considering a new sewer use ordinance that would enforce disconnection and provide financial assistance to property owners.

# Short Term Requirements Annual Report Form

## **3. Narrative Description of Progress Made Towards Long Term Operation and Maintenance Program Development:**

A plan and budgetary costs for citywide CCTV and mainline cleaning cycles has been developed. Acoustic testing has been performed in high priority areas to prioritize cleaning, and pipes subject to heavy sedimentation have been put on a shorter re-inspection cycle. A rate study is underway to determine whether sewer rates will need to be adjusted to pay for remediation of identified public sector sources and subsidies for private sector remediation. The city has also purchased six (6) flow meters and is currently flow monitoring the Meadow Ridge and Willow Glen subdivisions to prioritize future private sector investigations and measure progress toward I/I reduction.

# Short Term Requirements Annual Report Form

## 4. Summary of Sanitary Sewer Overflows (SSOs) and Basement Backups (BBs)<sup>1,2</sup>

<sup>1</sup>Include only Reportable Events, which are wet weather SSOs, dry weather SSOs, and BBs caused by public sewer surcharging and blockages under either wet or dry conditions. Do not include BBs caused by collapse/blockage of the private service lateral.

<sup>2</sup>See Sanitary Sewer Overflow and/or Basement Backup Satellite Entity Internal Summary for definition of "Occurrences" as used in table below.

	# of Occurrences in Dry Weather	# of Occurrences in Wet Weather	# of Occurrences for which cause is known	# of Occurrences outside of High Priority Sewer service areas	# of Occurrences for which cause has been eliminated
SSOs	0	7	7	1	0
BBs	3	85	85	6	2

# Short Term Requirements Annual Report Form

- A. If the causes for any SSOs/BBs for have not been determined, please provide the reason(s): There is one dry-weather BB that is still being investigated by the city and homeowner. It is currently suspected that a temporary blockage in the lateral or mainline sewer caused the backup, but both have been televised and were found to be clear of obstructions.
- B. If areas where any SSOs/BBs occurred are served by sewers that have **not** been classified or reclassified as High Priority Sewers, please provide the reason(s): During the May 3 storm event, there was one SSO and 6 reported backups that occurred outside of a previously identified high-priority area due to a power failure at a downstream lift station. A new backup generator has been installed.
- C. If there are causes for any SSOs/BBs that have not been eliminated, please provide the reason(s): Remaining SSOs and BBs were caused by excessive I/I. Identification and remediation of I/I sources is underway, and these causes will have been considered eliminated upon completion.

# Short Term Requirements Annual Report Form

## **Attachments:**

- Condition Assessment Prioritization Form and Map (required with first submittal of this report only)
- Map showing locations of Condition Assessment activities in reporting year (required every year; if credit for pre-IICP condition assessments is sought, map should show locations of pre-IICP assessments)
- Status of High Priority Deficiencies Form (required for years any High Priority Deficiencies have not yet been corrected, and for years immediately succeeding)
- CIP (required for years any public sector High Priority Deficiencies have not yet been corrected)



# Short Term Requirements Annual Report Form

**Certification:**

**I hereby certify that the information provided in the Annual Report is true and correct**

**Signature:** \_\_\_\_\_ **Date:** February 17, 2016

**Printed Name:** \_\_\_\_\_ **Title:** \_\_\_\_\_

**Telephone:** \_\_\_\_\_ **Email:** \_\_\_\_\_

# Short-Term Requirements Checklist

Satellite Entity	MWRD			Infiltration/Inflow Control Program (IICP)	WMO Reference
	Check if Provided	Check if Required	Check if Provided	Status	
				<b>Short Term Program Requirements</b>	
				<b>Prioritization of high risk public sanitary sewer system infrastructure (First year of IICP)</b>	§804.1.A.i
				Areas with Sanitary Sewer Overflows (SSOs) and/or Basement Backups (BBs)	
				Areas upstream of SSOs and BBs	
				Subbasins known to surcharge	
				Areas with excessive wet weather flows and/or lift station pumpage	
				Areas with system deficiencies that could result in system failure	

# Sanitary Sewer Description and Inventory

## SANITARY SEWER SYSTEM DESCRIPTION AND INVENTORY INFILTRATION & INFLOW CONTROL PROGRAM

Submit this form upon completion of condition assessment and after completing any substantial sewer system improvement.

**Date:** 10/27/15

**Reason for Submitting:**

- Completion of condition assessment
- Substantial sewer system improvement. Describe improvement: \_\_\_\_\_

# Sanitary Sewer Description and Inventory

## A. Sanitary Sewer System Description

1. Is part of the Agency's service area Combined? (check one)
  - No
  - Yes, \_\_\_\_\_% Combined
  
2. Separate Sanitary Sewer Service Area: 6,200 acres
  
3. Separate Sanitary Sewer Service Area Population Equivalent (PE<sup>1</sup>) Served:  
Residential: 46,000 Non-Residential: 2,700 Total: 48,700
  
4. Description of Municipal Sewer System Ownership: (check one)
  - Main line sewers only
  - Main line sewer and service lateral connection only
  - Main line sewer and service lateral to the ROW, easement, property line, or cleanout
  - Main line sewer and entire service lateral to the building
  - Other: \_\_\_\_\_

# Sanitary Sewer Description and Inventory

## B. Sanitary Sewer System Inventory (separate sewer area only)

### A. Sanitary Sewer System Inventory:

Gravity Sewer (ft)	Manholes	Force main (ft)	Lift Stations	Siphons	Connections to MWRD
500,000	2,000	22,700	8	0	3

### B. Age Distribution of the Collection System:

Age	Gravity (ft)	Force main (ft)	Lift Station
0 – 25 years	125,000	7,200	5
26 – 50 years	235,000	10,500	3
>51	140,000	5,000	0
Total	500,000	22,700	8

# Sanitary Sewer Description and Inventory

## C. Size Distribution of the Collection System:

Diameter	Gravity (ft)	Force main (ft)
≤8 inches	335,000	16,800
9 – 18 inches	87,000	5,900
19 – 36 inches	35,000	0
>36 inches	43,000	0
Total	500,000	22,700

# Sanitary Sewer Description and Inventory

## D. Distribution of Collection System by Material:

Material	Gravity (ft)	Force main (ft)
PVC	110,000	
RCP	62,000	
CP (Concrete Pipe)		
VCP (Vitrified Clay Pipe)	328,000	
CCCP (Prestressed Concrete Cylinder)		
Steel		
DIP		12,000
CIP		8,300
HDPE		2,400
FRP (Fiberglass Reinforced Plastic)		
RPMP (Techite)		
ACP (Asbestos Cement Pipe)		
Other:		
Other:		

# Sanitary Sewer Description and Inventory

## E. Number of Service Connections:

Residential	Commercial	Industrial	Other	Total
18,750	83	3	4	18,840

<sup>1</sup>PE = 100 gal/person/day



# Sanitary Sewer Overflow and/or Basement Backup Internal Summary

## SANITARY SEWER OVERFLOW and/or BASEMENT BACKUP SATELLITE ENTITY INTERNAL SUMMARY

Instructions: Use this form to document all sanitary sewer overflows and/or basement backup discharge occurrences. The following definitions apply:

**Sanitary Sewer Overflow:** the discharge of untreated sewage from the sanitary sewer collection system to a surface water, storm sewer or ditch, or the ground, due to the circumstances identified below.

**Basement Backup:** the discharge of untreated sewage into the lower level of a building due to the circumstances identified below.

Use one form per occurrence. A single occurrence may be longer than one day if the circumstance(s) causing the overflow and/or basement backup results in a discharge duration longer than 24 hours. If there is a start and restart of the overflow and/or basement backup within 24 hours and it is caused by the same circumstance(s), report it as a single occurrence. If discharge occurrences are separated by more than 24 hours, they should be reported as separate occurrences. If multiple overflows and/or basement backups occur resulting from the same circumstance, report it as a single occurrence.

The satellite entity must maintain all documentation and/or supporting information pertaining to information provided in this form on record and provide it to the MWRD if/when requested.

Satellite Entity: City of Highland Ridge

# Sanitary Sewer Overflow and/or Basement Backup Internal Summary

## Sanitary Sewer Overflow and/or Basement Backup Details:

Sanitary Sewer Overflow →  Dry Weather     Wet Weather (provide information below)  
 Basement Backup →  Dry Weather     Wet Weather (provide information below)

Start Date (mm/dd/yy):    Time:    AM    PM    Duration (hours and minutes):  
05/03/15    9:45            2:15

Estimated Volume (gallons):    Location (manhole number, address/major intersection, attach spreadsheet for multiple locations):  
1,350    MH 6-34, Lincoln and Main

Pump Used:    No     Yes     Pump Capacity: n/a GPM

# Sanitary Sewer Overflow and/or Basement Backup Internal Summary

## Circumstances Causing the Sanitary Sewer Overflow and/or Basement Backup (check all that apply):

- Rain
- Snow melt
- Widespread Flooding
- Power Outage
- Equipment failure
- Fats, Oils, Grease
- Collapsed Sewer
- Blocked Sewer
- Roots
- Lift Station Failure
- Forcemain Break
- Other (explain below)

Explain why the sanitary sewer overflow and/or basement backup occurred. For example, describe what equipment failed, what caused the power outage, or what caused the basement backup. Flooding should only be indicated as a cause if there is significant flooding caused by high river, stream or lake water levels, not just localized high water in the street.

Intense rainfall

# Sanitary Sewer Overflow and/or Basement Backup Internal Summary

## Wet Weather Event Information (if applicable):

Start Date: 05/03/15 Time : 8:15 AM  PM  End Date: 05/03/15 Time : 3:45 AM  PM

Amount of Rainfall (inches): 3.26 Amount of Snow Melt (Inches): 0.00 Contributing Soil Conditions (saturated, frozen, soil type):  
Damp; 1.5" of rain over previous 3 days

Peak 1-Hour Intensity (inches): 1.93 Rain Gauge Location:  
Public works garage

# Sanitary Sewer Overflow and/or Basement Backup Internal Summary

**Where Did the Discharge from the Overflow and/or Basement Backup Go? (check all that apply)**

- On the ground and absorbed into the soil
- Ditch: Name of surface water it drains into: \_\_\_\_\_
- Storm Sewer: Name of surface water it drains into: North Branch of Chicago River
- Surface water direct discharge: \_\_\_\_\_
- Basement Backup (number and use, i.e. residential, commercial, of buildings affected): \_\_\_\_\_
- Other (explain): \_\_\_\_\_

# Sanitary Sewer Overflow and/or Basement Backup Internal Summary

## **Actions to Correct This Occurrence and Prevent Future Overflows and/or Basement Backups:**

1. Describe what actions were taken to minimize the volume of wastewater discharged from the overflow and/or basement backup reported on this form.

The Merrick Lane wet-weather storage facility was pumped down prior to the storm, and the gate valve at the facility remained fully open during the event to maximize utilization of storage volume.

2. Describe if the occurrence reported on this form is part of an area subject to frequent and/or patterns of occurrences and if investigations have been or are planned to be conducted to determine the cause of the frequent and/or patterns of occurrences.

Yes, this manhole is in one of the previously identified high-priority areas and is currently being investigated to locate sources of I/I. Smoke testing and dye tracing in this area is planned for summer 2015.

3. Describe what corrective actions are planned to prevent or minimize future sanitary sewer overflows and/or basement backups.

Money has been budgeted to rehabilitate manholes and mainline sewers in this area in 2016 and 2017. Following the I/I source investigations, notifications will be sent to private property owners to encourage the disconnection of private sector sources.

# Sanitary Sewer Overflow and/or Basement Backup Internal Summary

**Final Determination for the Cause of the Overflow(s) and/or Basement Backup(s): (check one)**

Private Property Sewer → Explain: \_\_\_\_\_  
\_\_\_\_\_

Municipal Sewer → Explain: During the peak of the rain event, flow exceeded the mainline sewer capacity, causing it to surcharge and overflow.

**Report Completed By:**

Name: \_\_\_\_\_  
Title: \_\_\_\_\_  
Street Address: \_\_\_\_\_  
City: \_\_\_\_\_ ZIP: \_\_\_\_\_  
Phone: \_\_\_\_\_  
Email: \_\_\_\_\_

**Authorized Satellite Entity Representative:**

Name: \_\_\_\_\_  
Title: \_\_\_\_\_  
Street Address: \_\_\_\_\_  
City: \_\_\_\_\_ ZIP: \_\_\_\_\_  
Phone: \_\_\_\_\_  
Email: \_\_\_\_\_

\_\_\_\_\_  
Authorized Satellite Entity Signature

May 6, 2015  
Date

# Auditing

- The MWRD Reserves the Right to Audit Any Satellite Entity Following Submittal of the Short-Term Requirements Annual Summary Report. The Purpose of Such Audits Is to:
  - Review condition assessment / inspection documentation
  - Verify the quantity of assessment work performed within reporting years
  - Verify that assessments were conducted according to NASSCO standards, or approved equivalent standards
  - Verify that repairs of high priority deficiencies have been performed



# Auditing (Cont.)

- Review records of private property inspection program
- Review list of properties with high-flow, high-cost I/I sources
- Verify that detailed records of SSOs and BBs are kept



# TRAINING OUTLINE

- Historical Perspective
- WMO Article 8
- Infiltration/Inflow Basics
- **Technical Guidance Manual**
  - Definitions
  - Short-Term Requirements
  - **Private Sector Program**
  - Long-Term Program

# Private Sector Program (PSP)

- Staff / Training
- Local Authority
- Inspection
- Non-Compliance Correction
- Long-Term Program for High-Cost Sources
- Enforcement
- Funding
- Public Information

# Staff / Training

- Established Organization Structure with Defined Responsibilities
- List Staff Job Titles with Responsibility for Implementation of PSP
- Training for Internal / External Inspection and Documentation
- Proper Equipment / Materials



# Local Authority

- Enact Ordinance / Resolutions / Bylaws / Access Agreements for Access to Properties
- Authority to:
  - Conduct internal / external inspections
  - Conduct dye testing to confirm indeterminate sump discharge location
- Provide Copies of Ordinance to MWRD
- Examples of Existing Ordinances on MWRD Website



# Inspection

- Conduct in Areas Where Private Sector I/I Is Major Contributor
  - BBs and SSOs during multiple wet-weather events within 12-months
  - All Public Sector high priority defects are rehabilitated
  - Includes areas upstream
- Include Specific Criteria for Conducting Inspections on PSP
- Public Relations
  - Notice letters / newsletter / website
  - Door hangers
  - Notices of non-compliance



# Inspection

- May Be Coupled with Water Meter Reading Program
- See Inspection Checklist for Documentation Level
- Goal - Properties on 10-15 Year Inspection Cycle with Priority to Areas with SSOs and BBs
- Follow-up Dye Testing for Indeterminated Sump Discharge Locations



# Private Sector Inspection Checklist

## PRIVATE PROPERTY INSPECTION CHECKLIST

Inspection #: \_\_\_\_\_ Inspection Date: \_\_\_\_\_

Address: \_\_\_\_\_ Inspected By: \_\_\_\_\_

### GENERAL

1. Property Type:       Single Family       Multi Family       Commercial       Other
2. Sanitary Plumbing Type:       Gravity       Overhead
3. Foundation Type:       Basement       Crawl Space       Slab
4. Has the property experienced a sewer backup?       No       Yes
5. Has the property experienced stormwater flooding?       No       Yes

### EXTERNAL

6. Are there underground downspouts with no visible discharge location?       No       Yes
  7. Does the property have outside drains?       No       Yes
- 7a. If outside drains exist, record the number of each type:      Area \_\_\_\_      Driveway \_\_\_\_      Patio \_\_\_\_      Stairwell \_\_\_\_      Window  
Well \_\_\_\_



# Private Sector Inspection Checklist

## INTERNAL

8. Basement Dimensions: \_\_\_\_\_ x \_\_\_\_\_
9. Basement Grade: \_\_\_\_\_

## EJECTOR PUMP

10. Does the property have an ejector pump?     No                       Yes
11. Is the ejector pit sealed?                       No                       Yes
12. Where does the ejector pump discharge?     To Ground     To Sanitary     Unknown
13. Cover Type: \_\_\_\_\_
14. Check Valve:                                       No                       Yes

# Private Sector Inspection Checklist

## CLEARWATER SUMP

15. Does the property have a clearwater sump?  No  Yes
16. Where does the clearwater sump discharge?  Sanitary Sewer  Storm Sewer  Over Ground  Unknown
17. Are there any visible sanitary utilities entering the clearwater sump, i.e. is it a combination sump?  No  Yes
18. Identify the type of drains entering the sump pit:  Floor Drain  Footing Drain  Laundry Drain  Bathroom
19. Is the bottom of the sump pit sealed?  No  Yes
20. Cover type:  Bolted  Loose  None  Other \_\_\_
21. Check Valve:  No  Yes

# Private Sector Inspection Checklist

## INSIDE PIPING AND FLOOR DRAINS

22. Is there a direct connection between sanitary and clearwater piping?  No  Yes
23. Are there observable diverters?  No  Yes
24. Are there floor drains?  No  Yes
- 
24. Is there a suspected footing tile connection?  No  Yes

## DYE TEST

25. Were dye tests performed?  No  Yes

25a. List dye tests performed:

- \_\_\_\_\_ Positive?  No  Yes
- \_\_\_\_\_ Positive?  No  Yes
- \_\_\_\_\_ Positive?  No  Yes

# Private Sector Inspection Checklist

**COMMENTS:** \_\_\_\_\_  
\_\_\_\_\_  
\_\_\_\_\_  
\_\_\_\_\_

## NOTIFICATION CHECKLIST

Letter: \_\_\_\_\_  
1<sup>st</sup> Pass: \_\_\_\_\_  
2<sup>nd</sup> Pass: \_\_\_\_\_  
Final Notice: \_\_\_\_\_

# Non-Compliance Correction

- Notification and Correction Procedure
  - Method of notification
  - Schedule for correction
  - Verification through re-inspection
- Notification Letters
  - Describe non-compliant condition
  - Establish date for correction
  - Describe legal actions for failure to correct

# Non-Compliance Correction

- Educational Material
  - Types of disconnection / rehabilitation
  - List of bonded / licensed contractors
  - Funding assistance from Satellite Entity (if available)



# Long-Term Program for High Cost Sources

- Typical High Cost Sources
  - Directly connected foundation drains
  - Driveway drains
  - Area drains
  - Defective service laterals
- Document Location / Details of All High Cost Sources
- Optional Approaches for Removal
  - “Tear Down” requirements
  - Major home improvements
  - Overhead sewers
  - Cost sharing programs



# Enforcement

- Establish Hierarchy of Enforcement Actions
- Actions Written into Ordinance
- Establish Escalation of Penalties
  - Fines
  - Denial of service
  - Litigation



# Funding

- Appropriate Funding for Program Every Year
- Track Historical Costs for PSP Annual Budget
- Fund as Part of Sewer Maintenance Program
- PSP to Identify Annual Funding \$ and Funding Source



# Public Information

- Explain Public Health, Environmental, Regulatory Benefits
- Basic Sewer System and Infiltration/Inflow Concepts
- Brochures, Newsletters, Websites, Mailings, Insert in Water Bills, Emails
- Attach All Public Information Documents When Submitting PSP to MWRD
- Submit PSP to MWRD by July 2019

# Public Information

- Examples of Required Activities
  - Drafting language for inspection / required disconnection ordinance
  - Establishing variance procedure for unique individual disconnections related to unreasonable cost or lack of a feasible discharge location
  - Adopting ordinances for inspection program
  - Establishing rules and ordinance language for periodic re-inspection of homes

# Public Information (Cont.)

- Developing private property inspection procedures
- Establishing rules and ordinance language related to overhead sewer installation
- Posting all relevant documents and forms on the satellite system website and/or newsletters
- Training staff on how to conduct inspection of private property

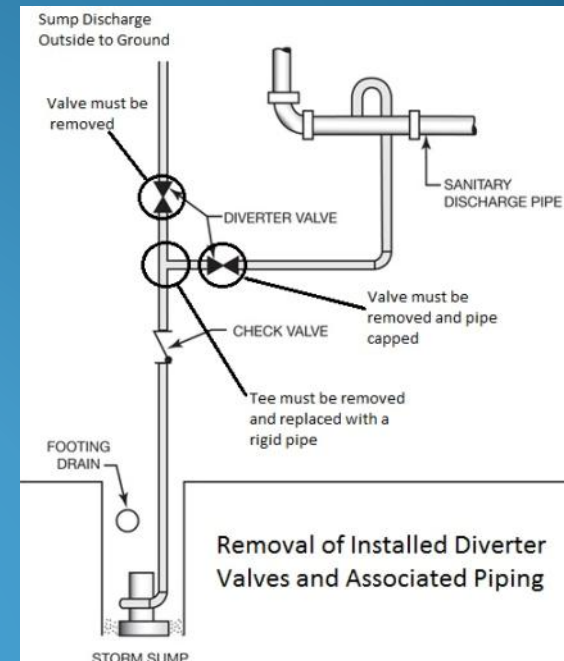

# Public Information

- Examples of Recommended Activities
  - Determining requirements for private sector inflow source removal cost-sharing program
  - Details for acceptable disconnection materials and methods
  - Developing rules, application, brochure for private sector inflow source removal cost-sharing program
  - Adopting ordinances for cost-sharing programs
  - Establishing rules and application form for backflow prevention devices, with and without pump-over capability

# Public Information (Cont.)

## Examples of Recommended Activities

- Establishing policy and ordinance language for elimination of all clear water sources in conjunction with a “tear down” or major renovation
- Establishing policy and ordinance for inspection of homes for compliance as part of all property transfers
- Examples of Similar Programs Administrated by Local Satellite Agencies Are on MWRD Website



# Private Sector Program Checklist

Satellite Entity Check if Provided	MWRD			Infiltration/Inflow Control Program (IICP) Private Sector Program (PSP) Requirements	WMO Reference
	Check if Required	Check if Provided	Status		
				<b>Staff/Training/Authority</b>	§804.1.C
				Organizational structure that defines responsibilities and authority for all staff	
				Periodic training of staff for inspections, documentation, etc.	
				Proper equipment to perform required PSP work (smoke/dye/camera, etc.)	
				List of staff job titles and associated responsibilities for PSP implementation	
				Estimated number of monthly hours for each staff member	

# TRAINING OUTLINE

- Historical Perspective
- WMO Article 8
- Infiltration/Inflow Basics
- **Technical Guidance Manual**
  - Definitions
  - Short-Term Requirements
  - Private Sector Program
  - **Long-Term Program**



# Long Term O&M Program (LTOMP)

- Continuously Implemented by Satellite Entities
- Public and Private Sector Sewers
- Adequate Funding and Staffing
- Required for a Successful I/I Control Program
- Based in Part on USEPA Capacity, Management, Operation and Maintenance (CMOM) Guidelines
  - Included in special conditions of MWRD NPDES Permits for MWRD's own Collection Facilities
  - CMOM guidelines useful when developing a LTOMP

# CMOM Guidelines

- Flexible, Dynamic Framework for Incorporating Industry Accepted Practices
- Understand Components that Make Up Sewer System and How System Performs
- Identify Goals and Objectives for Managing a Specific System
- Provide Necessary Program Structure to Allow Goals to Be Met
- Strive for Adjustment of Activities to Reflect Changed Conditions

# CMOM Guidelines (Cont.)

- Prepare For and Respond to Emergency Events
- Communicate with Interested Parties on the Implementation and Performance of the CMOM Program
- Additional CMOM Materials Available on MWRD Website



# Sewer System Management

- Staffing
  - Organizational structure with defined responsibilities/authority
  - Staff and/or outside contractors
- Training
  - Public relations, customer service, safety, sewer O&M activities, lift stations O&M, SSO/BB emergency response, inspection, repair, rehabilitation
  - Describe training program in LTOMP



# Sewer System Management (Cont.)

- Safety Training
  - Proper maintained equipment
  - Written procedures, policies, and courses
  - Confined space entry permits
  - Additional detail - 1989 O&M manual – See MWRD Website



# Sewer System Management (Cont.)

- Safety Training Programs Include:
  - Confined spaces
  - Chemical handling
  - Trenching and excavations
  - Material Safety Data Sheets (MSDS)
  - Biological hazards
  - Traffic control and work site safety
  - Lock-outs and Tag-outs
  - Electrical and mechanical safety
  - Pneumatic and hydraulic systems



# Sewer System Management (Cont.)

- Customer Service
  - Establish protocol for incoming inquiries, requests, or complaints from the public
  - Records kept of all
    - Date received
    - Location
    - Customer information
    - Date resolved
  - Basement backups
    - Depth of flooding in basement
    - Preceded by storm event
    - Power outage prior to backup
    - Time for backup to recede

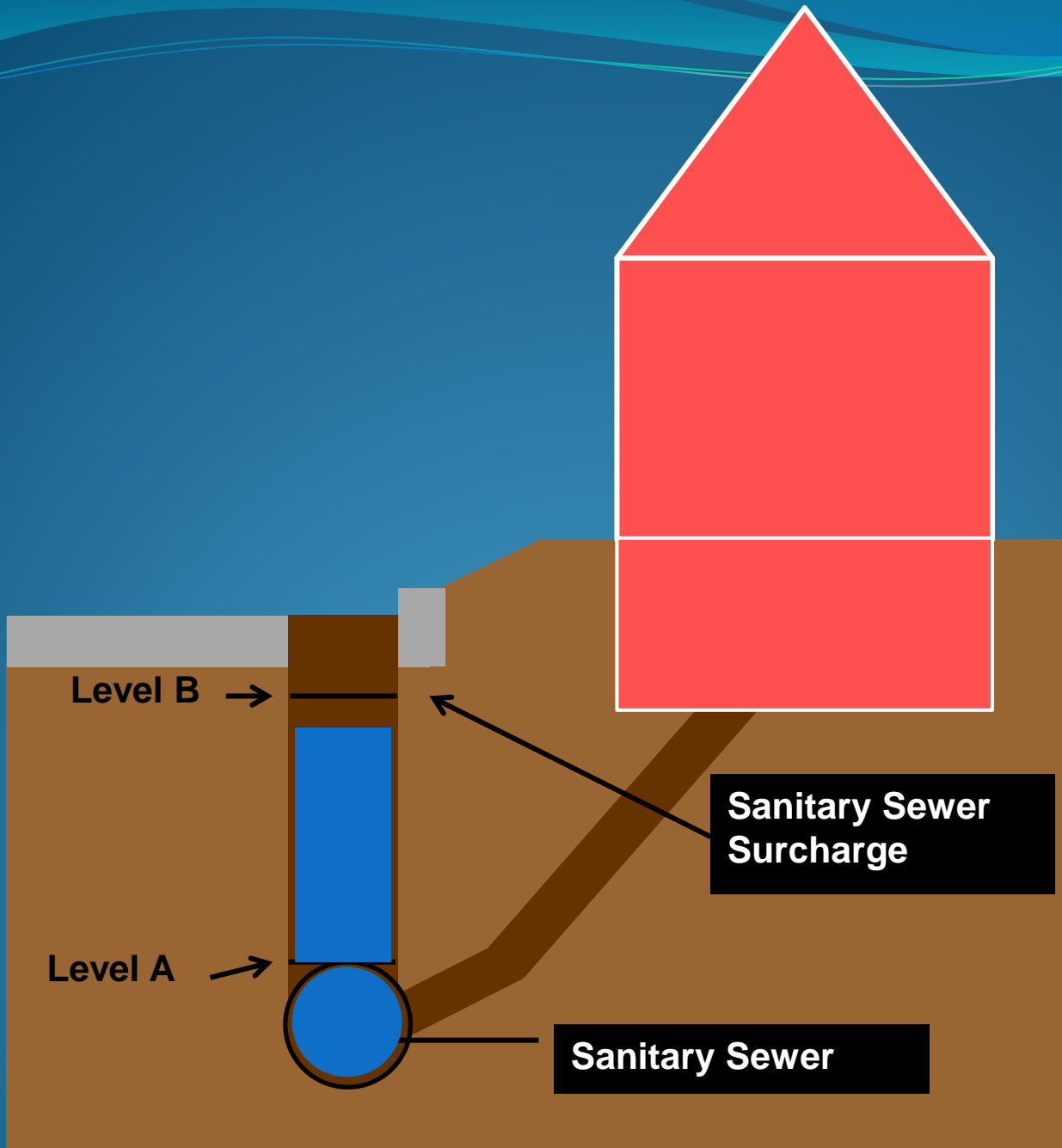



# Sewer System Management (Cont.)

- Computerized Maintenance Management System - Recommended, but Not Required
  - LTOMP to describe system for tracking/maintaining records
    - Customer response
    - Emergency response
    - Inspections
    - Maintenance
    - Asset inventory
    - Equipment and supply inventory
  - Utilize Geographic Information System (GIS) to map and locate all assets - Recommended, but not required
  - GIS and CMMS should be integrated

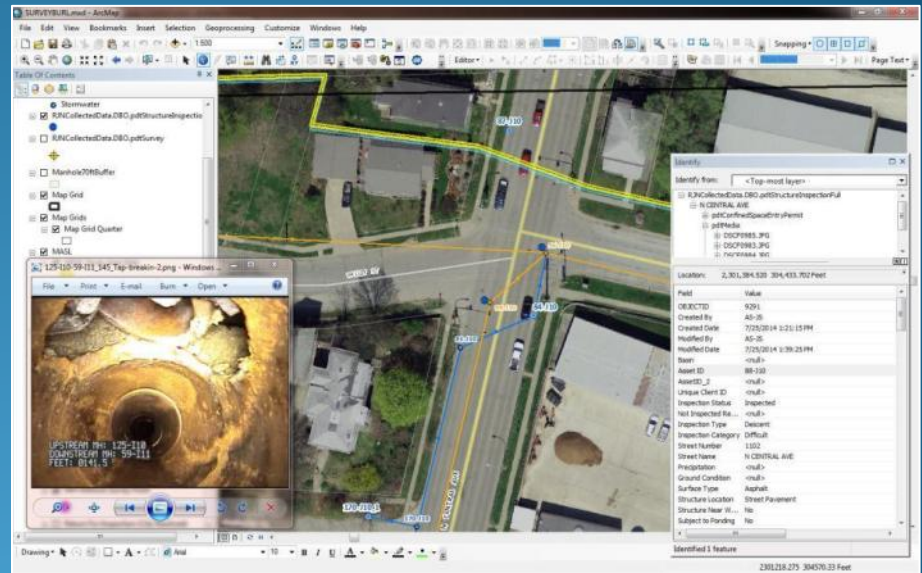

# Sewer System Management (Cont.)

- BB/SSO Notification Program

- Procedure for responding to BB/SSOs - Public & Private

- Information

- Date and time
- Location
- Cause
- Remediation
- Estimated volume
- Depth of flooding of basement
- Proceeded by storm event
- Power outage prior to BB/SSO



# Sewer System Management (Cont.)

## BB/SSO Notification Program

- Reporting procedure
  - All BB/SSOs recorded on BB/SSO Internal Summary Form
  - Summary provided to MWRD annually
  - BB due to private lateral blockage and unrelated to public sewer are not required to be reported



# Sewer System Management (Cont.)

- Emergency Preparedness and Response
  - Written plan for routine and catastrophic emergencies
    - BB/SSOs
    - Sewer breaks/collapse
    - Lift station power outage or pump failure
  - Utilize most recent information on sewer system



# Sewer System Management (Cont.)

- Emergency Preparedness and Response
  - Risk assessment for larger systems
    - Areas vulnerable to failure
    - Impact of failure on health and safety
    - Vulnerability assessment
      - Extreme weather events/natural disaster
      - Work stoppages
      - Accidents
      - Negligence



# Sewer System Management (Cont.)

- Emergency Preparedness and Response
  - Plans to ensure proper O&M for duration of emergency including contingency for
    - Inaccessibility of equipment or system components
    - Equipment failure
    - Power outages
    - Lost or interrupted communication
  - Identify all steps in response to emergency
  - Identify when procedures initiated/terminated
  - Detail equipment to be used in various situations

# Sewer System Management (Cont.)

- Emergency Preparedness and Response
  - Typical components of an emergency program may included the following
    - General information - telephone numbers of personnel, fire department and ambulance
    - Identification of hazards with classification, e.g., flammable, energized electrical circuits, etc.
    - Risk assessment vulnerabilities which identifies type of emergencies
    - Emergency response procedures
    - Methods to reduce the risk of emergencies
    - Responsibilities of staff
    - Continuous training
  - **Records of all past emergencies** for continuous improvement
  - Evaluate use of other entity departments/private contractors

# Mapping

- Accurate and Up-to-Date
- Submit to MWRD in Conjunction with LTOMP (Sooner if Available)
- Permanent Numbering System for Manholes/Cleanouts
- Show Extent of Service Area
- LTOMPs Must Include a Procedure for Updating the Sanitary Sewer Map Annually



# Sewer System Management (Cont.)

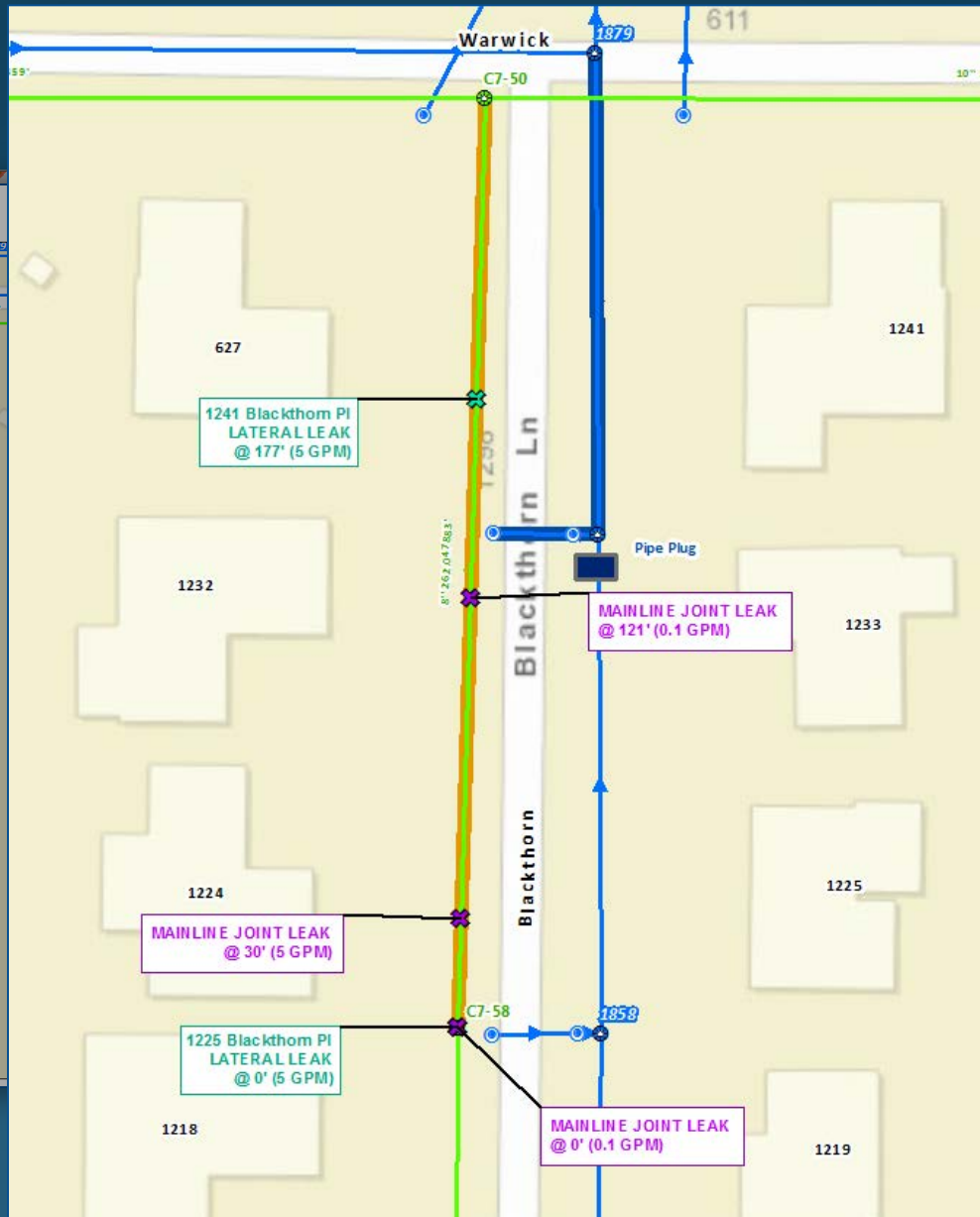

**Legend:**

- Sanitary Manholes
- Storm Manholes
- Sanitary Gravity Mains
- Storm Sewers
- Sewer Televising
- Area Flooded With Dye
- Storm Inlets
- Fire Hydrant

**Dye Water Flooding Defects:**

- BROKEN PIPE
- CRACKED PIPE
- LATERAL LEAK
- MAINLINE JOINT LEAK
- MANHOLE LEAK

**rjngroup**  
The Choice for Collection System Solutions

Village of Deerfield, IL  
Exhibit 1  
Deerfield Dyed Water Flooding:  
Setup 8: Segment C7-58 to C7-50  
November 2014

# Mapping (Cont.)

- Maps Should Contain the Following Information:
  - All mainlines sewers and force mains
  - Manholes and cleanouts
  - Lift Stations, siphons, diversion structures and overflows/bypasses
  - Building lateral connection point to mainline sewer
  - Service area boundaries
  - Roads, water bodies
  - Connections to MWRD Facilities
  - All Relevant Elevations, Diameters, Sizes and Materials

# Mapping (Cont.)

- Benefits of GIS Based Mapping (Recommended)
  - Efficient updates
  - Selectable map scale / sections / features
  - Most accurate method when coupled with GPS of manholes
  - Footprint of Buildings Served by the Public Sewer

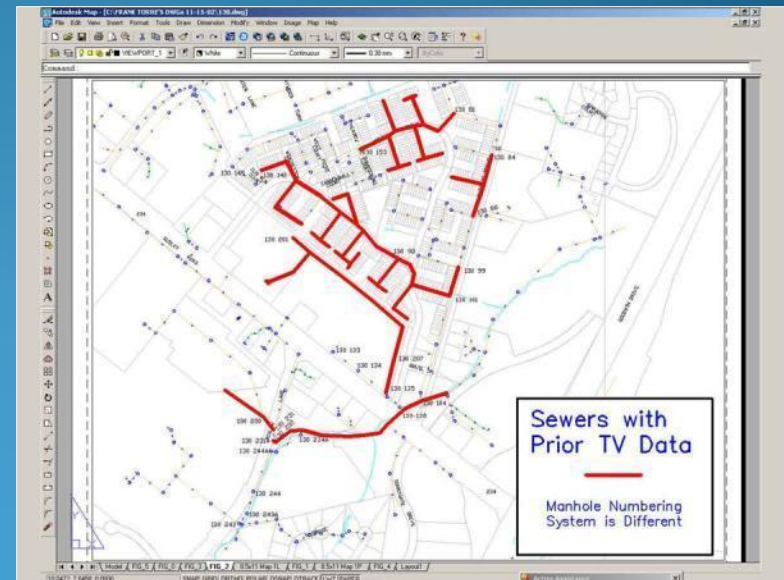

# Mapping (Cont.)

- The Procedure for Updating Maps Should Require Updates to Be Made Quickly. Typical Items Requiring Updating Include:
  - New sewer system extensions and additions
  - Changes from replacement / rehabilitation
  - Changes to appurtenances from replacement / rehabilitation
  - Location of service lateral connections to the mainline sewer after a television inspection is completed, if such information is not already available

# Mapping (Cont.)

- Corrections of map errors
- Documentation of completed rehabilitation work



# Equipment and Collection System Maintenance

- Goals
  - Preventing BBs/SSOs
  - Maximize service and system reliability
  - Reduce capital repair/replacement costs
  - Infrastructure sustainability
  - Sustain public confidence in the sewer system



# Equipment and Collection System Maintenance

- Planned Maintenance

- Systematic approach to avoid system / equipment failure
- **Preventive**
  - Record keeping provides “baseline data” on system condition
  - CMMS most efficient mechanism to manage maintenance data
  - Scheduled activities for cleaning and root removal, rehabilitation
  - Based on recent inspection data and maintenance history data
  - Manufacturers recommendations for equipment maintenance
  - Entire system may not require frequent maintenance
  - Baseline data will eventually result in a focus on the portions of system that require frequent preventative maintenance

# Equipment and Collection System Maintenance

## - Predictive

- Monitoring of equipment for early warnings of failure
- Prediction of sewer system failures (where and when) based on pipe characteristics
- Less expensive than emergency or preventive (“just in time” maintenance)
- Increases useful life of sewers / equipment

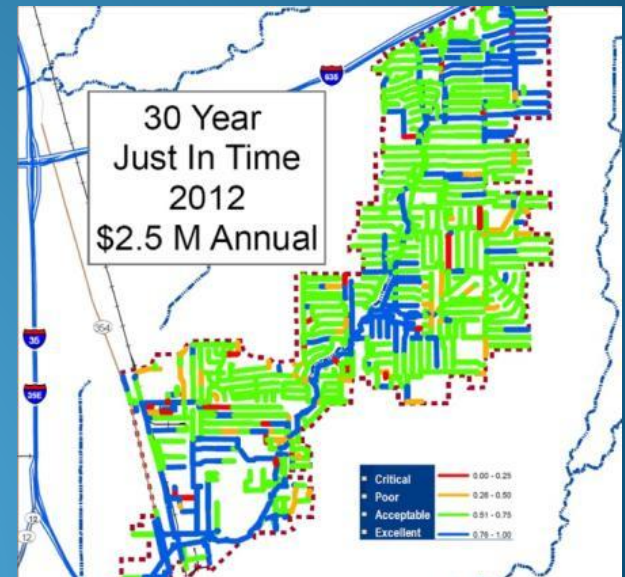



# Equipment and Collection System Maintenance

- **Unplanned Maintenance**
  - Emergency response to sewer / equipment failure
  - Corrective in response to preventive / predictive activities
  - Draws resources away from planned maintenance
  - Emergency crews or on-call crews available 24 hours / day
  - Implementation of preventive and predictive maintenance in LTOMP will reduce incidence of unplanned maintenance



# Equipment and Collection System Maintenance

- Sewer Cleaning
  - Remove accumulated material
  - Prevent system blockages
  - Prepare system for inspection
  - Methods include:
    - Hydraulic
      - Pressurized water through nozzles
      - Combination vacuum / jetting trucks
    - Mechanical
      - Bucket machines, scrapers, power rodders



# Equipment and Collection System Maintenance

- Chemical
  - Common ingredients require strict adherence to manufacturers' recommended procedures
- Root Control
  - Chemical foaming
  - Mechanical rodding
  - Jetting with cutting heads
- Accurate records of areas susceptible to deposits / blockages
- Adjust cleaning cycles based on prior cleaning history
- See 1989 Manual for detailed advantages / disadvantages



# Equipment and Collection System Maintenance - Cleaning Options

Solution to Problem	Emergency Stoppages	Grease	Roots	Sand, Grit, Debris	Odors
Balling		●		●	●
High Velocity Cleaning	●	●●●		●	●
Flushing					●
Sewer Scooters		●		●	
Bucket Machines, Scrapers				●	
Power Rodders	●	●	●		
Hand Rods	●	●	●		
Chemicals		●	●		●

- = Most Effective Solution for a particular problem
- = Least Effective solution for a particular problem

Source: U.S. EPA, 1993.

Source: USEPA, 2002, Collection Systems O&M Fact Sheet Sewer Cleaning and Inspection.

# Equipment and Collection System Maintenance

- Lift Stations

- Electrical, hydraulic and mechanical components
- Key operational data to be collected and kept current include the following:
  - Station drawings
  - Wet well dimensions and key elevations
  - Pump on/off levels
  - Level of influent pipes and tributary sewers relative to on/off set points
  - Pump model(s) and impeller trims
  - Pump curves and design points



# Equipment and Collection System Maintenance

- Size of pump discharge piping and force mains
- Types and condition of valves
- Manufacturer data sheets for equipment
- Calibration records for level and flow monitoring equipment

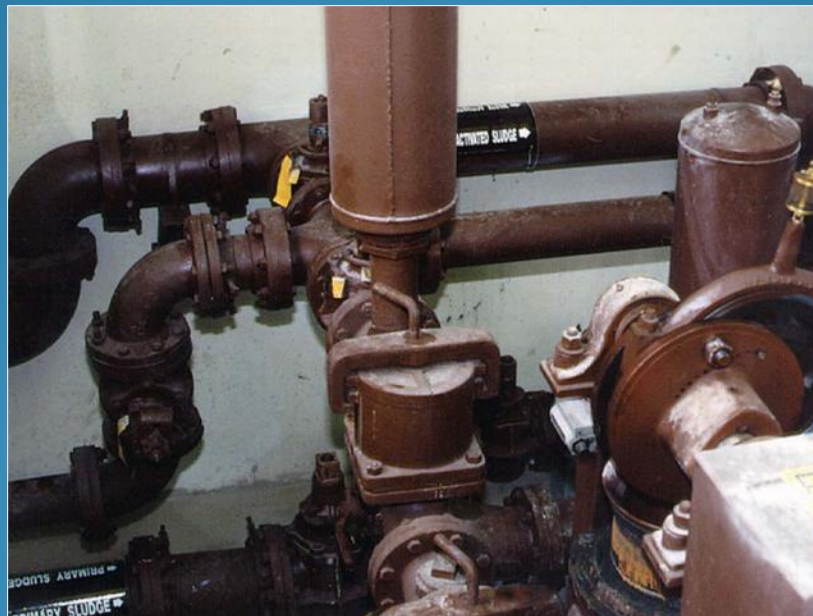

# Equipment and Collection System Maintenance

- The **lift station O&M manual** should consider the variation of equipment types, configuration, etc., and should contain written procedures for the following:
  - Automatic or manual pump rotation and frequency
  - Wet well operation levels to limit pump starts and stops
  - Procedure for manipulating pump operations during wet-weather to increase in-line storage of wet-weather flows



# Equipment and Collection System Maintenance

- How flow is measured (if applicable) and how used
- Assessing whether the lift station has capacity related or maintenance related overflows, and whether overflow monitoring is and should be provided





# Equipment and Collection System Maintenance

- Use of floats for primary or backup level control
- History of power outages / source of emergency power
- Procedure for regularly exercising the emergency generator (if present) under load



# Equipment and Collection System Maintenance

- Force Mains
  - Annual route inspections
    - Force main surface conditions
    - Unusual noise / vibration
    - Pipe leakage / displacement
  - Lift Station / Force Main
    - Valve condition
    - Pump station calibration
    - Changes in pump capacity/discharge head



# Fats, Oils & Grease (FOG) Programs

- Recommended But Not Required under WMO Article 8
- Proactive and Effective Control of Release of FOG
- FOG Cools in System / Adheres to Pipe Walls / Manholes
- Food Source Establishments, Large Apartment Complexes
- Large Contributor to Dry-Weather Blockages/Overflows
- Reduce Cleaning / Emergency Maintenance Costs
- Grease Traps / Interceptors-Design, Installation and Maintenance

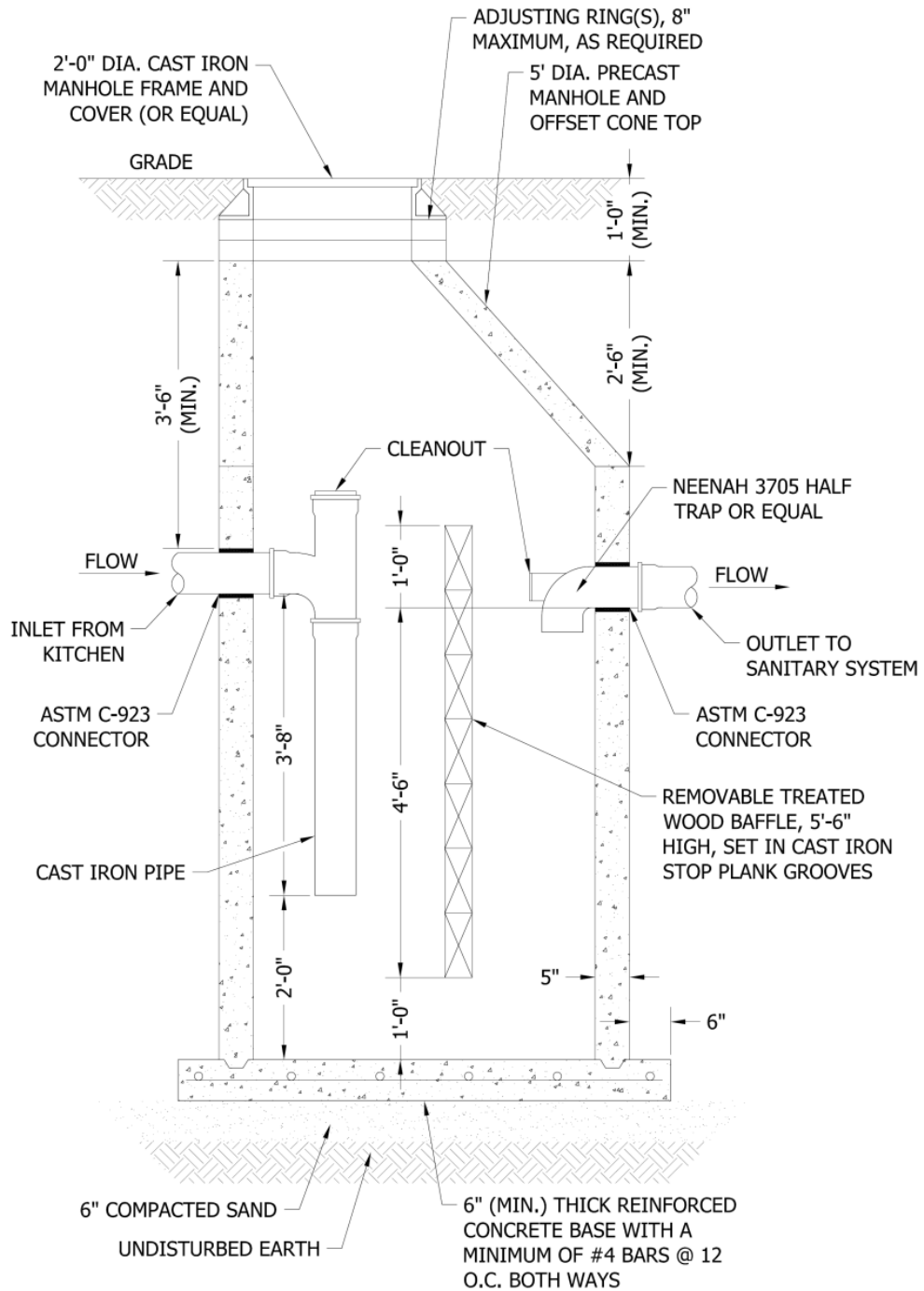

# Fats, Oils & Grease (FOG) Programs (Cont.)

- Establish Legal Authority and Describe Requirements for:
  - Plan review and design standards
  - Inspections
  - Permitting and control mechanisms
  - Enforcement
  - Communication
  - Performance measures
  - Public education
  - Information management system

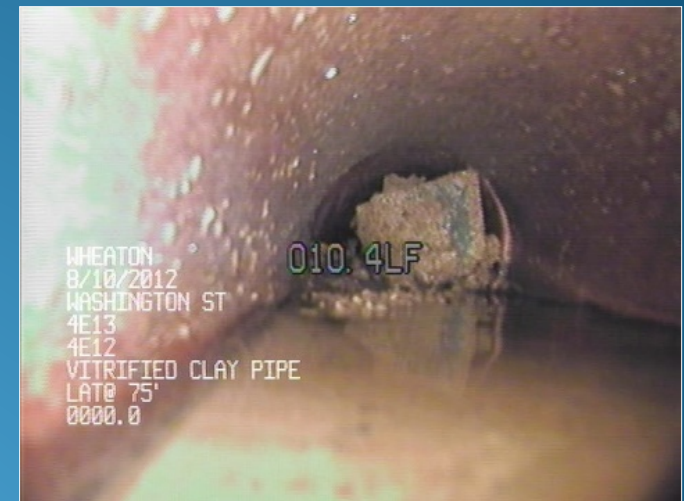

# Material and Equipment

- Inventory of Parts, Equipment and Supplies Per Manufactures' Recommendations / Historical Records Including Safety Equipment
- Stock High Use / Difficult to Obtain Parts / Supplies
- LTOMP to Identify Individual(s) Responsible for Developing and Maintaining Inventory and Process for Procuring Spare Parts, Supplies and Equipment



# Material and Equipment (Cont.)

- Inventory Codes for:
  - Type
  - Age/Year of acquisition
  - Description
  - Manufacturer
  - Year for replacement
  - Special requirements
  - Repair history
- Detailed List of Recommended Equipment and Supplies in MWRD O&M Manual - 1989 Chapter 8



# Sewer System Capacity Evaluation

- May Be Required if:
  - Area with dry-weather SSOs/BBs not due to maintenance issues / deteriorated sewers
  - Area being developed or redeveloped and projected dry-weather flow exceeds that of current land use





# Sewer System Capacity Evaluation (Cont.)

- Begin with Inventory and Characterization to Include
  - Population served and service area
  - Total system size
  - Inventory of length, size material, age and condition
  - Inventory of lift stations, siphons including size, capacity material, age and condition
  - Manhole rim and inverts
  - Sewer slopes and inverts
  - Force main locations, length, size, material and condition
  - Location of laterals

# Sewer System Capacity Evaluation (Cont.)

- Sewer Sizing Per Article 7 of TGM
- Lift Station Design Capacity Per Article 702.2E2 of TGM
- System Improvements to Address Dry-Weather Flow Capacity Require MWRD WMO Permit



# Sewer System Inspection/Condition Assessment

- Continuous Program of Inspection/Rehabilitation
- Part of Preventive Maintenance Program
- Identify Defects and Schedule for Repair before Failure
- Eventual Inspection of Entire Public Sewer System after High Risk Areas Completed
- Categorize Balance of System (Manholes, Gravity Sewers, Lift Stations, Force Mains) for Prioritization into
  - High Risk / high frequency of inspection
  - Medium Risk / medium frequency of inspection
  - Low Risk / low frequency of inspection

# Sewer System Inspection/Condition Assessment

- LTOMP to Describe Continuous Inspection Program with Frequency and Methods of Inspection
- Goal is 10-year Cycle, Minimum is 2% Per Year
- All Inspections in Accordance with NASSCO Defect Coding Standards
  - Structural or O&M defects
  - 1 to 5 severity scale
  - Prioritize rehabilitation work
  - Overall line segment severity rating



# Sewer System Inspection/Condition Assessment

- Compatible with GIS/CMMS database and allow defect thematic mapping (Recommended)
- In-house or outside contractor with NASSCO defect coding certification

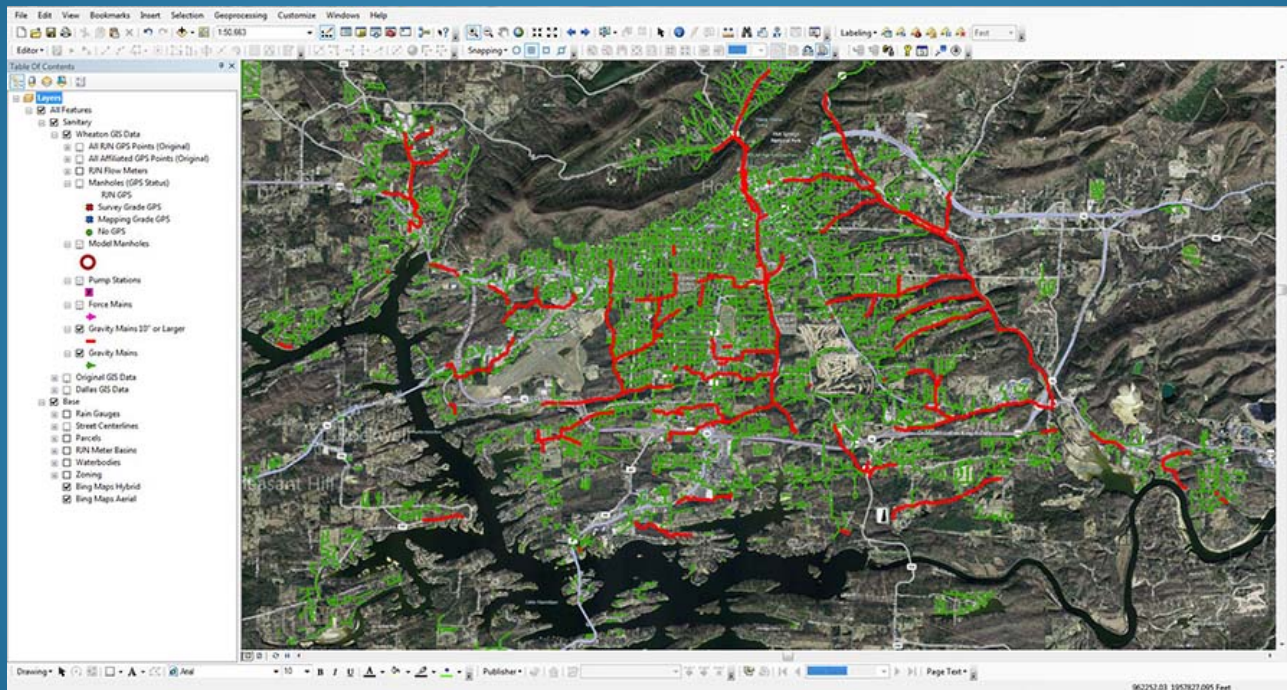

# Sewer System Inspection/Condition Assessment

- NASSCO Rating in LTOMP O&M
  - Privatize defects on severity plus criticality of failure
  - Compare previous inspections for deterioration rate
  - Map segments subject to FOG - frequent maintenance
  - Accurate locations of service connections
  - Updates for pipe material, size, and condition based on inspections



# Sewer System Inspection/Condition Assessment

- Program for Inspecting All New Construction Both Public and Private
- Requirements for Inspection of New Construction Should Be in Local Ordinance



# Flow Monitoring

- Recommended But Not Required Under WMO Article 8
- Information on Dry-Weather and Wet-Weather Flow
- Instantaneous
  - Single reading for a small area rain fall response
- Temporary/Short Term
  - 30 to 120 days
  - 15,000 to 25,000 linear foot intervals
  - Identify areas with high wet-weather flows
  - Develop relative ranking of subareas





# Flow Monitoring (Cont.)

- 3 to 4 Storm Events Normally Sufficient
- Wet-Weather Flow / Rainfall Relationship
  - Correlation requires at Least 6 measurable events  $\geq 0.15$  inch per hour
  - No surcharge
  - Antecedent moisture conditions
- Permanent
  - Evaluate pre- and post-rehabilitation flow rates
  - Evaluate multiyear rehabilitation programs
  - Up to 100,000 linear foot interval

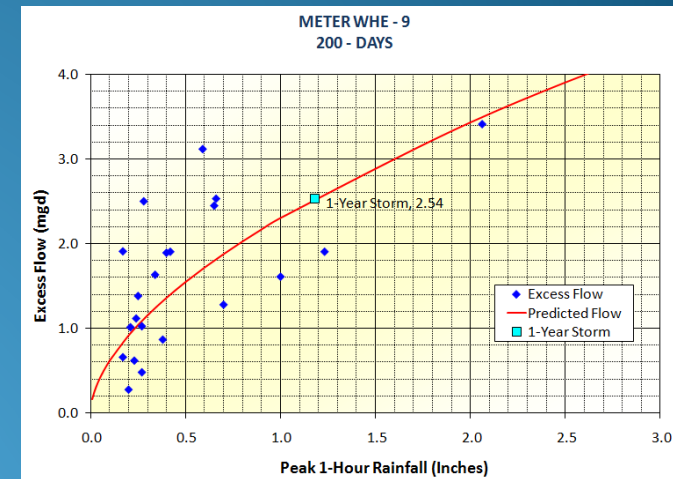

# Flow Monitoring (Cont.)

- Recommended Procedures
  - Redundant depth sensors / Doppler Velocity Sensor
  - Short Term Monitoring - site calibration and meter maintenance during installation, removal and semi-weekly unless site is on telemetry
  - Long Term Monitoring - minimum of monthly calibrations and site maintenance unless site is on telemetry
  - Continuous recording rain gauges at approximately 1 gauge per 8 flow meters, minimum of 2 gauges

# Flow Monitoring (Cont.)

- Data:
  - Log interval every 5 minutes for meters / rain gauges
  - Temporary/Short Term Program
    - Data review weekly during first 3 weeks of installation
    - Minimum of 2 calibration readings
  - Permanent/Long Term Programs
    - Minimum of monthly calibration and site maintenance unless site is on telemetry
  - Continuing recording rain gauges -  
approx. 1 gauge per 8 meters  
and minimum of 2 rain gauges

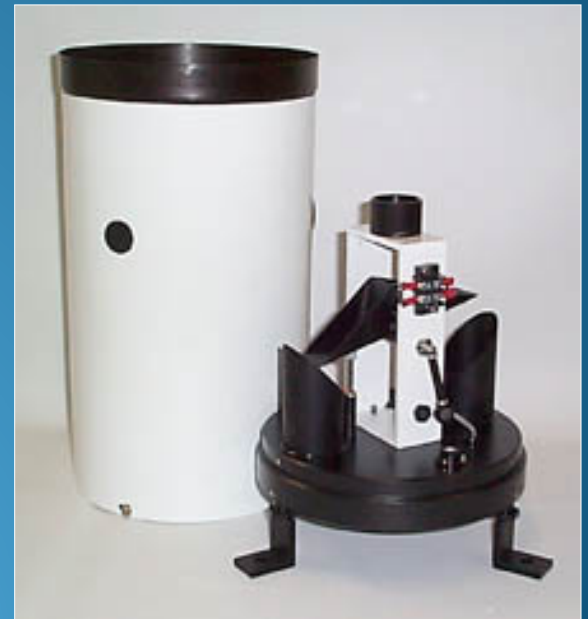

# Flow Monitoring (Cont.)

- Data analysis to identify gaps, hydraulic anomalies and meter performance
- Data correction for field calibrations and flow balance among connecting sites

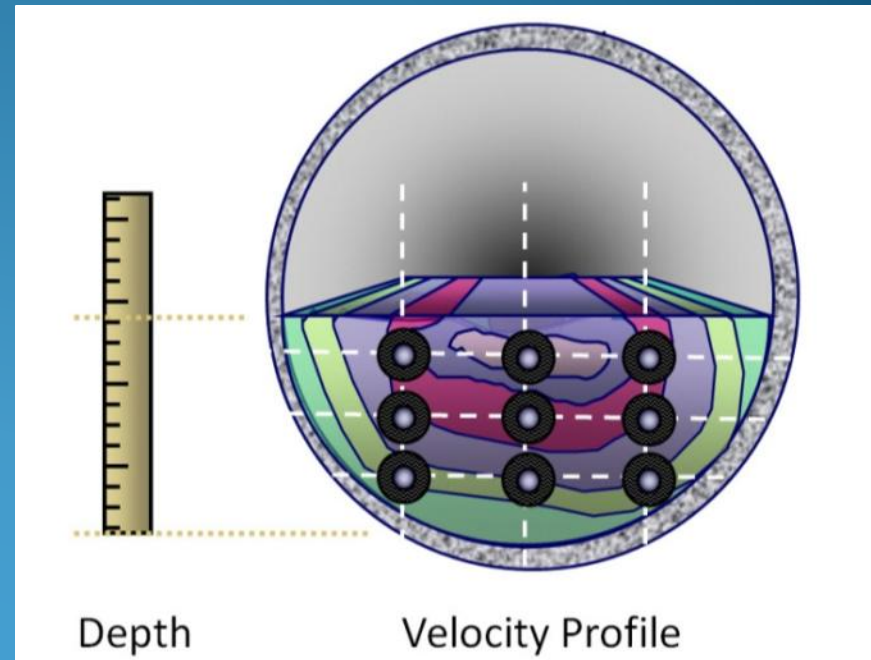

# Sewer System Rehabilitation & Updating CIP

- Objectives
  - Ensure structural integrity
  - Limit loss of conveyance
  - Utilize all information from LTOMP
- Rehabilitation Techniques Driven by Pipe Characteristics and Cost

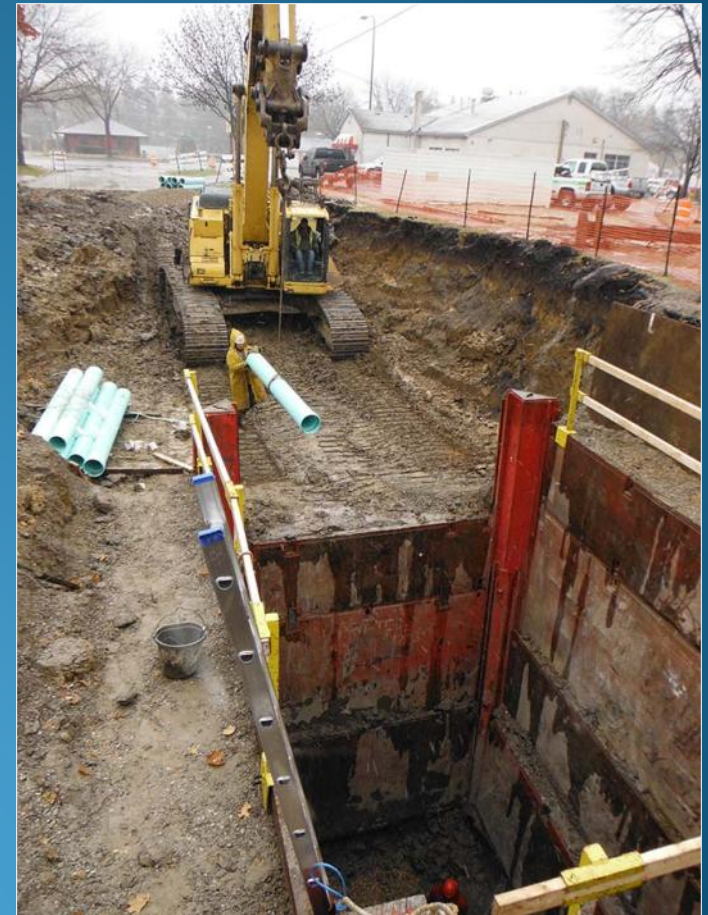

# Sewer System Rehabilitation & Updating CIP

- Pipe Rehabilitation
  - Open-cut:
    - Point repairs
    - Pipe replacement
  - Trenchless
    - Cured-in-Place Lining
    - Sliplining
    - External grouting
    - Internal joint sealing



# Sewer System Rehabilitation & Updating CIP

- Manhole Rehabilitation
  - Cover/frame replacement
  - Frame adjustments
  - Cementitious Lining
  - Epoxy lining
  - Grouting
- Service Lateral Rehabilitation
  - Complete/partial replacement
  - CIPP with or without installation of cleanout
  - Grouting

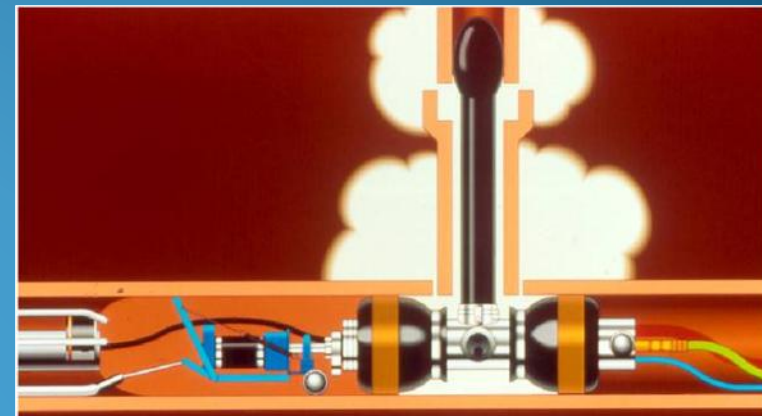

# Sewer System Rehabilitation & Updating CIP

- WEF Manual of Practice FD-6 for Rehabilitation Techniques
- Rehabilitation Work Prioritized by Defect Severity and Potential Impact of Failure
- Rehabilitation Projects to Be included in CIP
- Complete Rehab Work Tracked in Sewer Map/GIS
- LTOMP to Describe Procedures for Prioritization



# Local Storage Requirements

- Supplement to an Active Sewer Maintenance/Infiltration Inflow Reduction Program to Alleviate BBs/SSOs
- Flows (Wet-Weather Only) Stored and Later Released to Sanitary Sewer When Capacity Available
- Sizing Based on Volume to Prevent BBs and SSOs at Selected Design Storm
- Permit from MWRD/IEPA Required
  - Conduct Meeting with MWRD Prior to Permit Application
  - Analysis of impacts of storage facility on reducing SSOs/BBs

# Local Storage Requirements

- Efforts to reduce I/I tributary to proposed storage facility if tributary area not classified as high risk - public and private sectors
- Allowable discharge rate if upstream of lift station based on dry-weather flow of tributary population
- Evaluate odor control options
- Include Cleanup and Maintenance Plan
- Minimize Ground Water Intrusion
- MWRD Will Consider Permit Application at Any Point in IICP

# Local Storage Requirements

- MWRD Will Review Annual Infiltration/Inflow Summary Reports to Evaluate if Active Sewer Maintenance Program Is in Place



# Individual Backflow Prevention

- Measures Taken by Property Owners to Prevent Backup from Public Sewer
- Typically Used When Risk of BB Is High and Measures to Prevent Public Sewer Backup by Flow Reduction or Capacity Improvements Are Insufficient
  - Ground profile is low relative to adjacent properties
  - Grade elevation is low relative to the invert of the public sewer
  - Properties near a lift station where the wet well level can influence the water level in upstream sewers
  - Lateral connections to a large-diameter public main

# Individual Backflow Prevention

- Locations near the confluence of large diameter sewers and/or force main discharges
- Locations near connection to a regional interceptor that exerts downstream control on the local public sewer main
- Properties amid clusters of properties with large inflow sources, which collectively can overburden a small-diameter public main
- Common Devices Include
  - Stand pipes and plugs
  - Backwater valves
  - Overhead sewers
  - External pump over

# Individual Backflow Prevention

- Require Local building Permit, Disconnection of Private Sector I/I Sources as Condition
- Funding Often Shared by Property Owner/Public Entity

## TYPICAL INSTALLATION OF AN EXTERIOR DUAL BACKFLOW VALVE

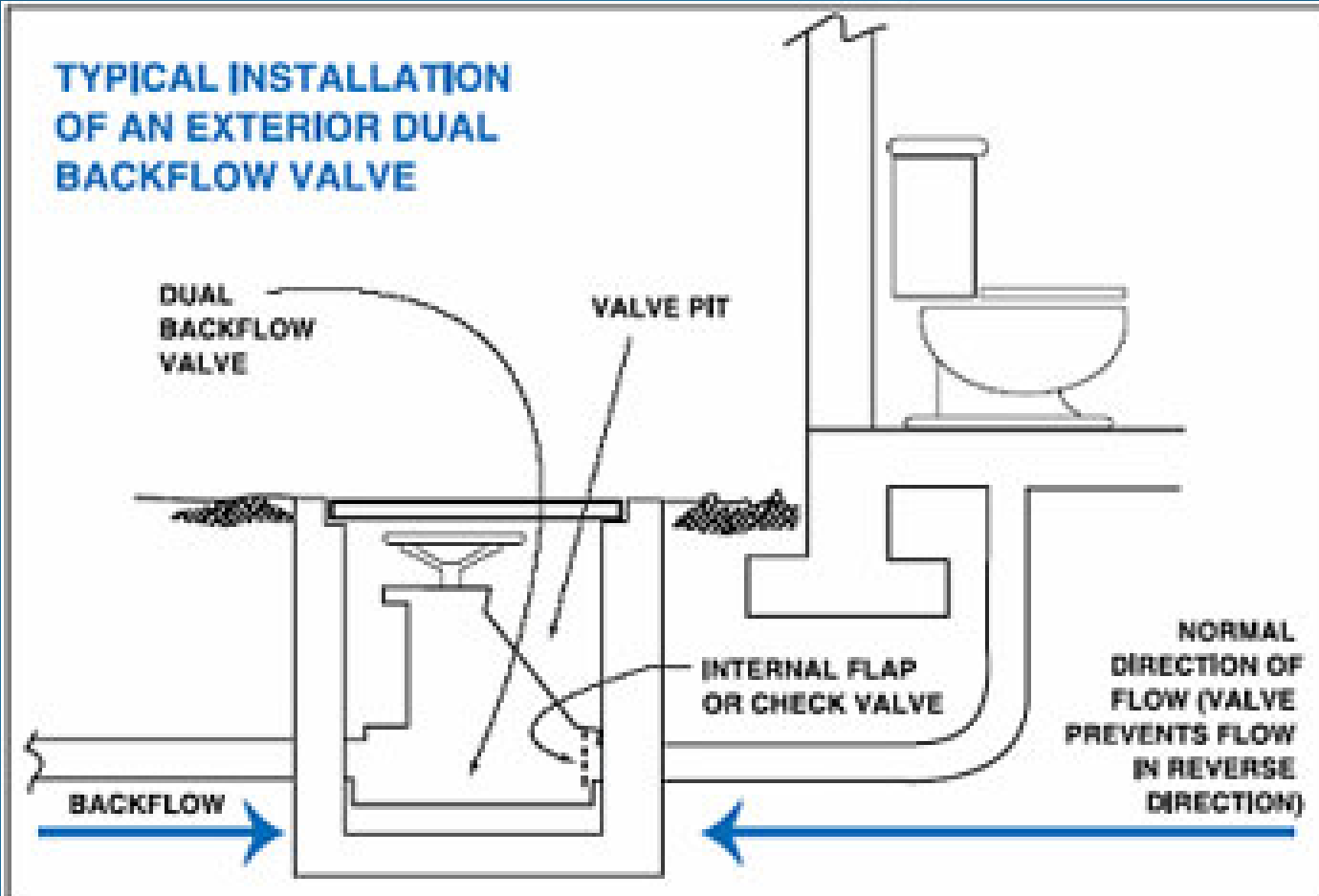

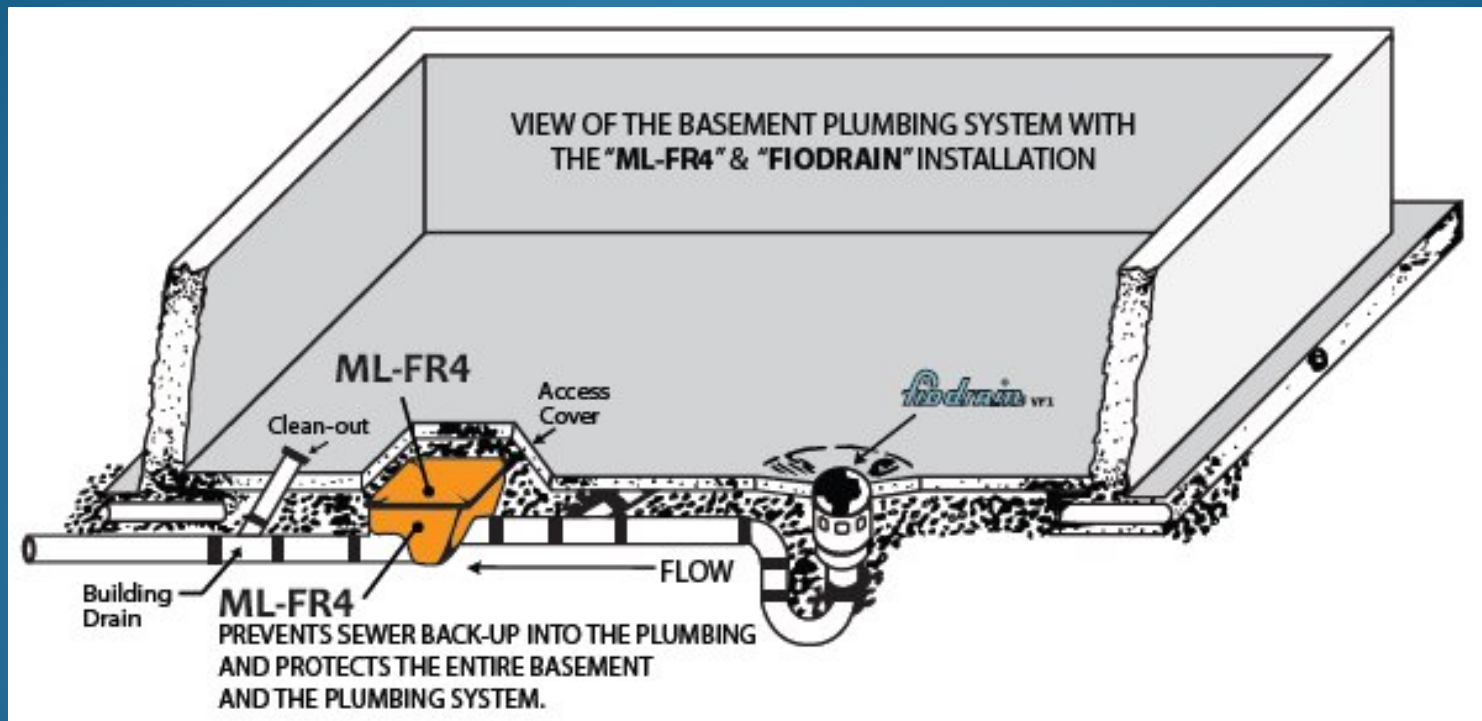



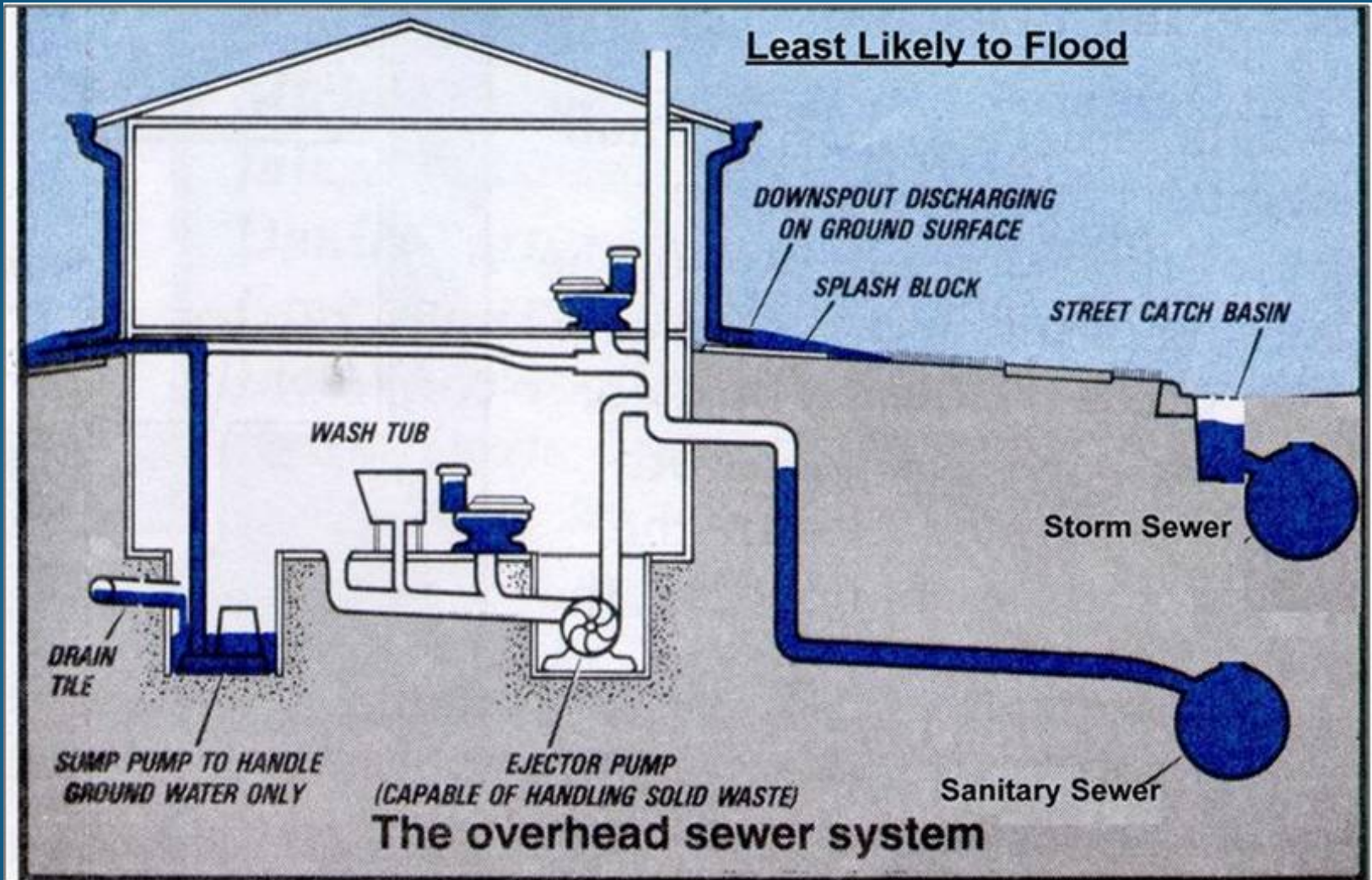

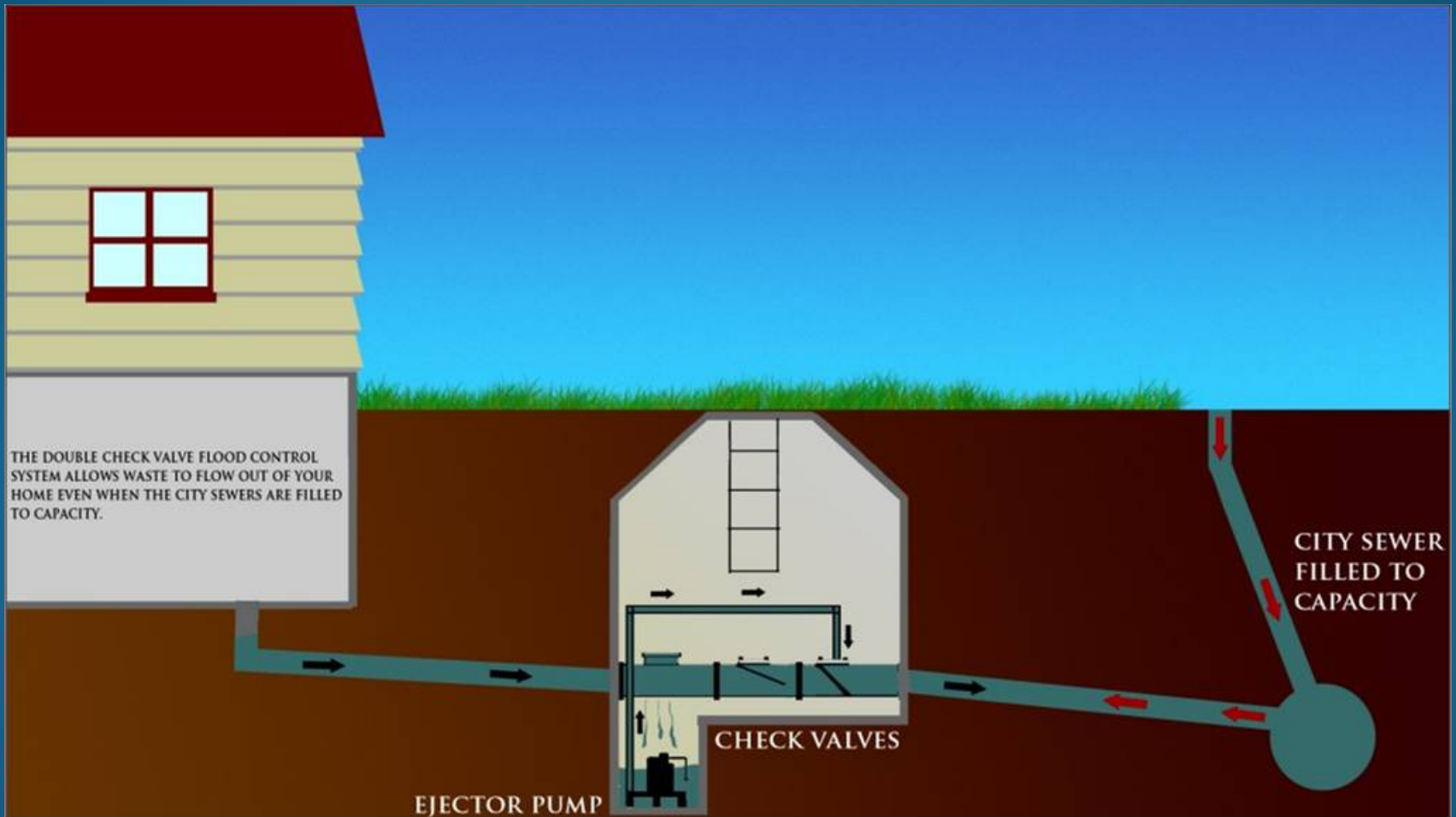

# Sewer Use Ordinance & Enforcement

- Authority Required For:
  - Control of the quantity and quality of wastewater from new development and any satellite collection systems
  - Control of sources of infiltration and inflow
  - Control of sources of Fats, Oils and Grease (FOG)
  - Requiring proper design and construction of new and rehabilitated sewers and connections
  - Requiring proper installation, testing and inspection of new and rehabilitated sewers
  - Access to all components of the collection system

# Sewer Use Ordinance & Enforcement (Cont.)

- Authority Normally Is Provided in Sewer Use Ordinance or Service Agreements



# Sewer Use Ordinance & Enforcement (Cont.)

- At a Minimum Sewer Use Ordinance Will:
  - Identify acceptable uses of the sanitary sewer system
  - Establish a procedure for authorization to connect
  - Establish enforcement measures or penalties
  - Describe regulations concerning industrial waste
  - Place limits on the quantity and composition of waste that is discharged to the system
  - Authorization to inspect new sewer construction
  - Authorize the satellite entity to inspect private property for improper and/or illegal connections to the sewer system

# Sewer Use Ordinance & Enforcement (Cont.)

- Enforcement Mechanisms:
  - Fines
  - Court orders
  - Shutoff of water service
  - Refusal to grant requests for additional service(s)
  - Refusal to grant building permits for additions or modifications to the property
  - Refusal to approve sale or transfer of a property
- Review of Ordinance Changes with Public Officials, and Residents Important Prior to Implementation

# Funding Plan

- Secure Funding Source to Continually Implement LTOMP
  - Water use fees
  - General fund revenue
- Availability of All LTOMP Costs for Annual Budget Review
- Annual Budget Should Include:
  - Preventive maintenance
  - Emergency maintenance
  - Major repairs
  - System rehabilitation
- IEPA SRF Loan program

# Sample LTOMP Template

## LONG TERM OPERATION & MAINTENANCE PROGRAM ANNUAL SUMMARY REPORT INFILTRATION & INFLOW CONTROL PROGRAM

Do not leave any blank spaces on this form, except where indicated. Use "X" for checking applicable information. Submit any supporting documentation when/where required. Submit a Sanitary Sewer System Description and Inventory Form upon completion of condition assessment and for any substantial sewer system improvement.

**Reporting Period:** January 1<sup>st</sup> to December 31<sup>st</sup>, 2021

**Latest version of the sanitary sewer atlas is dated:** November 2019      **Format:**  Paper    GIS    CAD

**Satellite Entity Information:** (to be completed by Public Works Director, or similar)

**Satellite Entity:** City of Highland Ridge  
**Address:** \_\_\_\_\_ **City:** \_\_\_\_\_ **Zip:** \_\_\_\_\_

**Representative:** \_\_\_\_\_ **Title:** Director of Public Works  
**Telephone:** \_\_\_\_\_ **Fax:** \_\_\_\_\_ **Email:** \_\_\_\_\_

**Certification:**

**I hereby certify that the information provided in the Annual Report is true and correct.**

**Signature:** \_\_\_\_\_ **Date:** \_\_\_\_\_



# Sample LTOMP Template

## I. Event Reporting

### A. Basement Backups (BBs): (reportable events only)

	BBs for Current Year	BBs for Previous Year
Number of Occurrences	12	27

1. Were BBs addressed by installing overhead sewers (OHS), backflow prevention devices (BPD), local storage facilities (LSF), or other measures? (indicate number addressed)

No

Yes # of OHS: 8 #of BPD: 2 # of LSF: 0

Other Explain: \_\_\_\_\_

2. Describe reason(s) if cause(s) could not be identified and/or addressed:

*Several homes in the vicinity of the Brainerd Road Lift Station backed up during the April 13 storm. Phase I engineering for upgrades to the lift station and/or local storage are currently underway.*

3. Describe how many of the BBs reported above are recurring (i.e. more than one occurrence during the reporting year) and action taken for investigation and their elimination:

Number of recurring events: 1

Action taken: Overhead sewer connection was installed with assistance of city subsidy.

# Sample LTOMP Template

## B. Sanitary Sewer Overflows (SSOs):

### 1. SSO Reporting:

	Dry Weather for Current Year	Dry Weather for Previous Year	Wet Weather for Current Year	Wet Weather for Previous Year
Main Line	0	1	4	9
Lift Station	0	0	2	3

### 2. Describe how many of the SSOs were identified and/or eliminated or if the cause could not be identified and/or eliminated:

*All SSOs occurred due to wet-weather flows in excess of system capacity. Capacity and storage options in these locations are currently under review.*

### 3. Describe how many of the SSOs reported above are recurring (i.e. more than one occurrence during the reporting year) and action taken for investigation and their elimination:

Number of recurring events: 3

Action taken: Feasibility analysis for wet-weather pumping to local storage

# Sample LTOMP Template

## II. Sanitary Sewer System Inspection & Maintenance:

### A. Inspection of Sanitary Sewer System

	Main Line (Ft)	Force main (Ft)	% of Total	Manholes (Nos)	% of Total
CCTV	65,000		13.0		
Smoke Testing	30,000		6.0	120	6.0
Dye Testing	10,000		2.0	36	1.8
Visual <sup>1</sup>				250	12.5
Acoustic Emissions Testing		1,450	6.5		
Pole Camera Inspection				2	0.1
Other:					

(1) Visual inspection of manholes includes surface inspections and full descent inspections of manholes. Such inspections shall be performed in accordance with NASSCO standards.

### B. Lift Station Inspection

	Inspected and Serviced (Nos)	% of Total in System
Lift Stations	8	100.0

# Sample LTOMP Template

## C. Maintenance of Sanitary Sewer System

	Sewer (ft)			Appurtenances (Nos)	
	Main Line	Force Main	% of Total	Manholes	% of Total
Cleaning	8,200	0	1.6	35	1.7
Root Cutting	6,400	0	1.3	25	1.3
Chemical Root Control	21,000	0	4.2	82	4.1
FOG treatment	40,000	2,300	8.4	153	7.6
Other:					
Other:					

## D. High Priority Deficiencies: (submit a status of High Priority Deficiencies Form and CIP for deficiencies identified but not corrected during the reporting year)

Type	Identified (length or number)	Corrected (length or number)
Main Line	5	2
Manholes	1	1
Lift Stations	0	0

## E. Estimated Annual Expenditure

Budget for Reporting Year: \$650,000

Expenditures for Reporting Year: \$587,000

# Sample LTOMP Template

## III. Sanitary Sewer System Rehabilitation

### A. Public Sector Rehabilitation:

#### 1. Main Line Sewer:

	Length or Number	% of System
Replacement	260	0.1
CIPP Lining	11,000	2.2
Point Repairs	1	
Grouting	0	
Cross-Connections	3	
Other:		

#### 2. Manholes:

Complete Rehabilitation	Partial Rehabilitation	Replacement	Grouting
3	23	2	37

#### 3. Lift Stations:

Number	Type of Rehabilitation
1	Replaced comminutor; rehabbed dry well

# Sample LTOMP Template

## B. Private Sector Rehabilitation:

1. I/I Sources Identified: (submit a list of property addresses for those not corrected and a schedule for correcting them)

	Number of Properties Identified	Removed/Corrected
Downspout	2	2
Area Drains/Driveway Drains	1	0
Open Cleanout	7	7
Storm Sump to Sanitary	11	2
Storm Sump w/divert valve	9	4
Combination Sump	5	0
Unsealed Sanitary Sump	2	0
Window Well Drains	16	13
Foundation Drains	3	0
Lateral	57	3

## IV. Sanitary Sewer System Flow Monitoring

**Was flow monitoring of the sanitary sewer conducted during the reporting year?**

- No (skip remaining questions in Section IV)  
 Yes (provide information requested below)

### A. Flow Monitoring Equipment:

Number of Flow Meters: 3

Start Date of Flow Monitoring: 3/4/2021

End Date of Flow Monitoring: 9/7/2021

Were rain gauges used?  No  Yes

If used, provide rain gauge location(s): public works garage

# Sample LTOMP Template

## B. Flow Monitoring Service Area & Results:

### 1. Service Area Information & Results:

Service Area Number	Service Area Size (acres)	Service Area PE <sup>1</sup>	Average Dry Weather Flow (gpcpd)	Peak Wet Weather Flow (gpcpd)	Peak Wet : Average Dry Weather Ratio
1	135	731	82	910	11.1
2	220	1,377	113	1,035	9.2
3	76	525	76	289	3.8

<sup>1</sup>PE = 100 gal/person/day

2. For service areas with Peak Wet : Average Dry Weather ratios above 4:1, describe how areas will be prioritized for I/I investigation and removal/rehabilitation:

*Manhole inspections and smoke testing in Service Areas 1 and 2 with follow-up dye testing has been budgeted for the coming year.*

# Long Term O&M Program Checklist

Satellite Entity	MWRD			Infiltration/Inflow Control Program (IICP) Long Term O&M Program (LTOMP) Requirements	WMO Reference
	Check if Required	Check if Provided	Status		
				<b>Sewer System Management</b>	§805.3.A
				Staff/Training/Safety	
				Organizational structure that defines responsibilities and authority for all staff	
				Description of staff safety/training programs	
				Customer Service	
				Protocols for handling inquiries, requests and complaints from the public	
				Management Information Systems	
				Description of Computerized Maintenance Management System (CMMS) used to track and maintain records of sanitary sewer system information	
				SSO/BB Notification Program	
				Procedure for reporting SSO to appropriate parties	
				Procedure for cleaning a site following an SSO	
				Procedure for responding to and inspecting BBs	
				Annual summary of SSOs and BBs submitted to MWRD	
				Emergency Preparedness and Response	
				Development of written emergency response plan for both routine and catastrophic emergencies	
				Records of all past emergencies	



# Annual Reporting

- Short Term and Long Term Requirements
- Reports Required Regardless of Degree of Progress
- Supplemental Documents May Be Required with Forms
- Reference Only Activities within Separate Sewer Areas
- Reports Due by March 1<sup>st</sup> Covering Activities for Prior January 1 to December 31

# Annual Reporting (Cont.)

Report Due Date	Reporting Year	Report Form
March 1, 2015	January 1, 2014-December 31, 2014	•ICAP Annual Summary Report
March 1, 2016	January 1, 2015-December 31, 2015	•Short Term Requirements Annual Summary Report
March 1, 2017 to March 1, 2020	January 1, 2016-December 31, 2016 January 1, 2017-December 31, 2017 January 1, 2018-December 31, 2018 January 1, 2019-December 31, 2019	•Short Term Requirements Annual Summary Report Until Entity Completes Short Term Requirements. <u>Then</u> use Long Term O&M Program Annual Summary Report Form
March 1, 2021	January 1, 2020-December 31, 2020	•Long Term O&M Program Annual Summary Report

# Annual Reporting (Cont.)

## Calendar Year

2016

(For 2015  
Activities)

## Reports Due to MWRD

- **Short Term Requirements Annual Summary Report**
- **Condition Assessment Prioritization Form**
- **Map showing High Risk Sewer Areas and areas upstream, service area boundaries, prior condition assessment work (one map acceptable)**
- If prior condition assessment credit requested - show areas with work on high risk sewers between July 10, 2009 and July 10, 2014 including when work performed and in accordance with NASSCO Standards. Also documentation of any high priority defects
- **Sanitary Sewer Description and Inventory Form**
- If high priority defects have been identified but not corrected, submit status of High Priority Deficiencies Form
- If high priority defects have been identified but not corrected and are to be addressed on CIP Plan, submit CIP Plan

# Annual Reporting (Cont.)

## Calendar Year

2017-2020

(For 2016-2019  
Activities)

## Reports Due to MWRD

- **Short Term Requirements Annual Summary Report until Entity Completes Short Term Requirements (no later than 2019)**
  - **Status of High Priority Deficiencies Form**
  - **Update CIP**
  - **Updated sewer map showing locations of condition assessment activities performed in reporting year**

# Annual Reporting (Cont.)

## Calendar Year

2020 and after  
(or sooner if  
entity completes  
short term  
program)

## Reports Due to MWRD

- Long Term O&M Program and Summary Report
- Status of High Priority Deficiencies Form
- CIP showing when high priorities deficiencies will be addressed
- List of property addresses where private sector sources have been identified but not corrected
- Schedule for correcting private sector I/I sources

## Other

- Service provision to previously unsewered areas or full combined sewer separation requires a revised Sanitary Sewer System Description and Inventory Form

# Enforcement by MWRD

- Non-Compliance
  - Inadequate progress in completing short term program requirements by 2019
  - Failure to adequately implement an approved LTOMP
  - Failure to adequately implement an approved PSP
  - Failure to submit an Annual Report
  - Submission of an Annual report that does not meet requirements

# Enforcement by MWRD (Cont.)

- Administrative Proceeding - Notice of Non-Compliance
  - Notice of Non-Compliance letter to satellite entity
  - Require schedule for correction of non-compliance
  - Conciliation meeting
- Administrative Proceeding - Show Cause Hearing

# Enforcement by MWRD (Cont.)

- Penalties
  - Loss of eligibility for funding assistance by MWRD
  - Loss of status as Authorized Municipality
  - Reporting of non-compliance to IEPA/USEPA
  - Denial of watershed management permit for qualified sewer construction



# Enforcement by MWRD (Cont.)

- Injunctive Relief - Addition to Above Penalties MWRD may:
  - Apply to Circuit Court of Cook County for issuance of injunction
    - Restraining satellite entity from violating or further violating Article 8
    - Failing to comply with a MWRD Board Order

# Reference Documents

- Joint Committee on Administrative Rules. 2014. Administrative Rules: Chapter I, Title 77, Subchapter r, Part 890: Illinois Plumbing Code.

Available at:

<http://www.ilga.gov/commission/jcar/admincode/077/07700890sections.html>

- Monitoring and Management Services. Fats, Oils, and Grease (FOG) Management & Control Program.

Available at:

[http://www.waterboards.ca.gov/rwqcb7/water\\_issues/programs/pretreatment/docs/intro\\_fog\\_inspections.pdf](http://www.waterboards.ca.gov/rwqcb7/water_issues/programs/pretreatment/docs/intro_fog_inspections.pdf)

# Reference Documents

- MWRD. 1989. Operations and Maintenance Manual for Separate Sanitary Sewer Collection Systems for Local Agencies Tributary to the Metropolitan Sanitary District of Greater Chicago.

Available at:

[http://pepportal.mwrld.local:50100/irj/go/km/docs/documents/MWRD/internet/Departments/Engineering/Doing\\_Business\\_with\\_Engineering/htm/Infiltration\\_and\\_Inflow/Infiltration and Inflow Operations Manual.htm](http://pepportal.mwrld.local:50100/irj/go/km/docs/documents/MWRD/internet/Departments/Engineering/Doing_Business_with_Engineering/htm/Infiltration_and_Inflow/Infiltration_and_Inflow_Operations_Manual.htm)

# Reference Documents

- National Association of Sewer Service Companies (NASSCO). Performance Specification Guideline for Sanitary Sewer Smoke Testing. December, 2010.
- National Association of Sewer Service Companies (NASSCO). Pipeline Assessment and Certification Program (PACP®) Latest Version.
- US Environmental Protection Agency. 2005. Guide for Evaluating Capacity, Management, Operation, and Maintenance (CMOM) Programs at Sanitary Sewer Collection Systems. Available at: [http://www.epa.gov/npdes/pubs/cmom\\_guide\\_for\\_collection\\_systems.pdf](http://www.epa.gov/npdes/pubs/cmom_guide_for_collection_systems.pdf)

# Reference Documents

- US Environmental Protection Agency Region 1. 2009. Template for Developing Sewer Collection System Preventive Maintenance and Sewer Overflow Response Plans; Assistance for Capacity, Management, Operations and Maintenance of your Sewer Collection System.

Available at:

<http://www.epa.gov/region1/sso/toolbox.html>

# Reference Documents

- Water Environment Federation. 2009. Manual of Practice for Existing Sewer Evaluation and Rehabilitation No. FD-6
- Water Environment Federation. 1999. Manual of Practice for Prevention and Control of Sewer System Overflows No. FD-17